

SOUND & HEARING

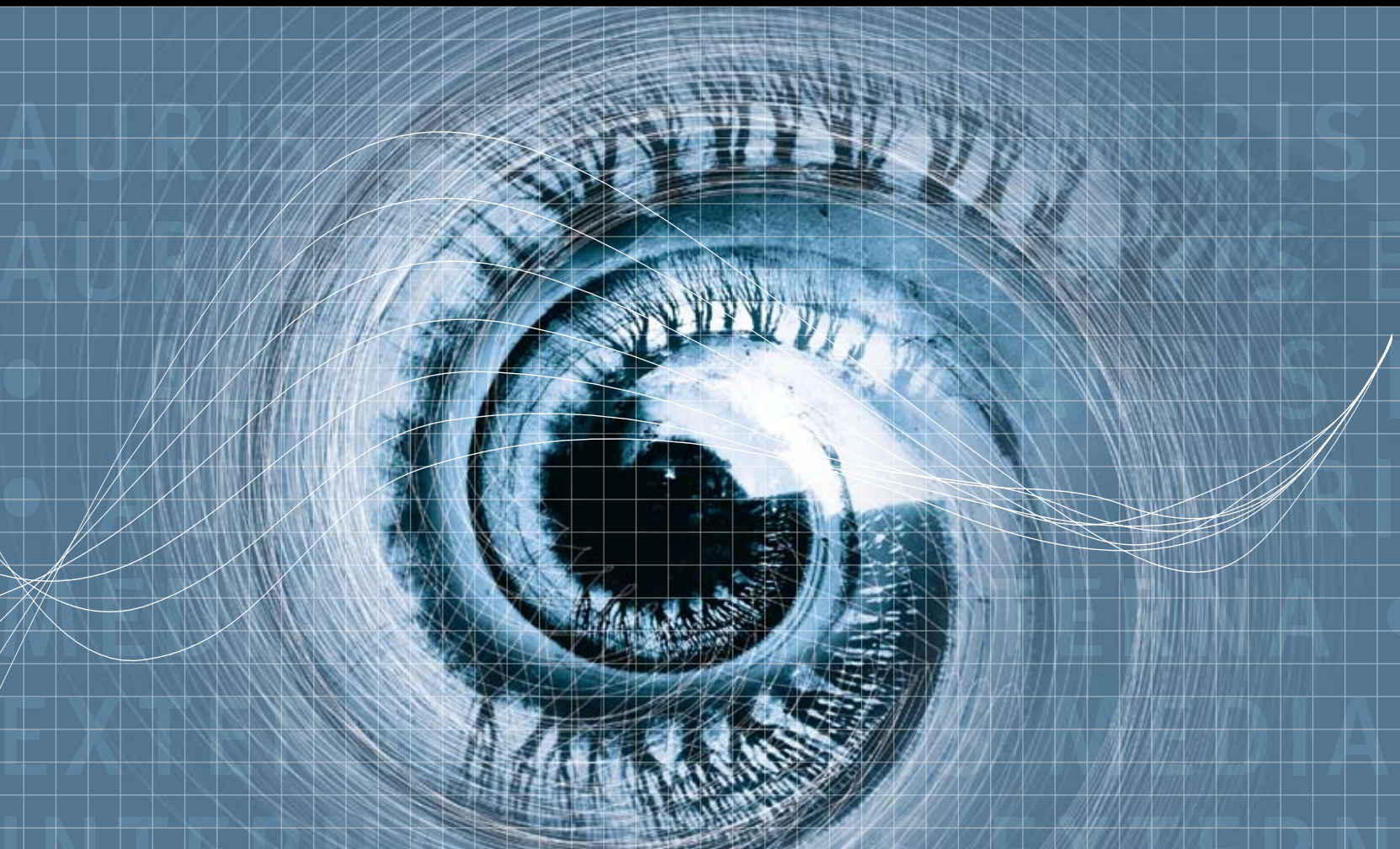

WIDEX[®]
high definition hearing

A series of approximately seven thin, white, wavy lines that flow from the left side of the frame towards the right. The lines are smooth and undulating, resembling sound waves or a stylized landscape. They are set against a solid, medium-blue background.

SOUND AND HEARING

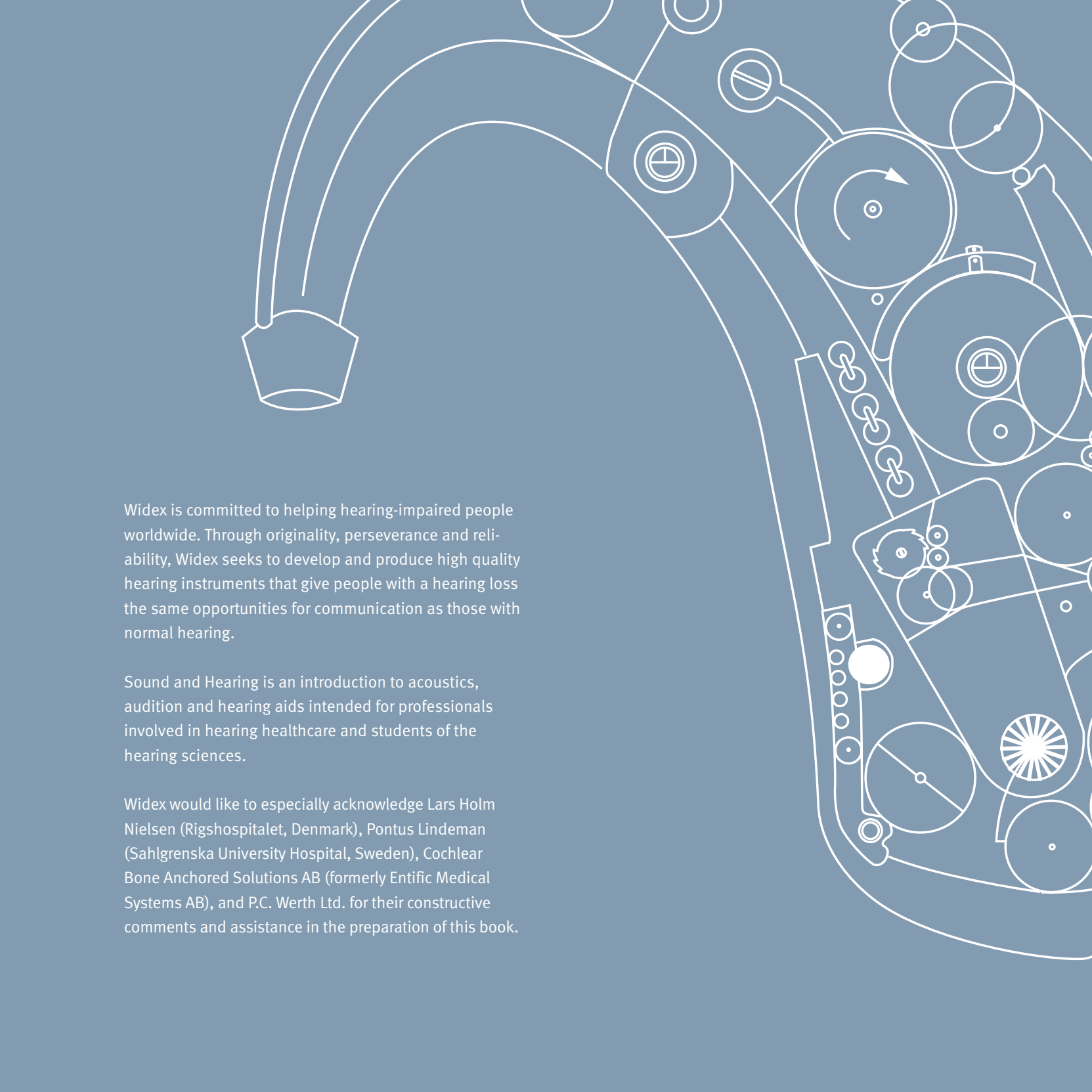

Widex is committed to helping hearing-impaired people worldwide. Through originality, perseverance and reliability, Widex seeks to develop and produce high quality hearing instruments that give people with a hearing loss the same opportunities for communication as those with normal hearing.

Sound and Hearing is an introduction to acoustics, audition and hearing aids intended for professionals involved in hearing healthcare and students of the hearing sciences.

Widex would like to especially acknowledge Lars Holm Nielsen (Rigshospitalet, Denmark), Pontus Lindeman (Sahlgrenska University Hospital, Sweden), Cochlear Bone Anchored Solutions AB (formerly Entific Medical Systems AB), and P.C. Werth Ltd. for their constructive comments and assistance in the preparation of this book.

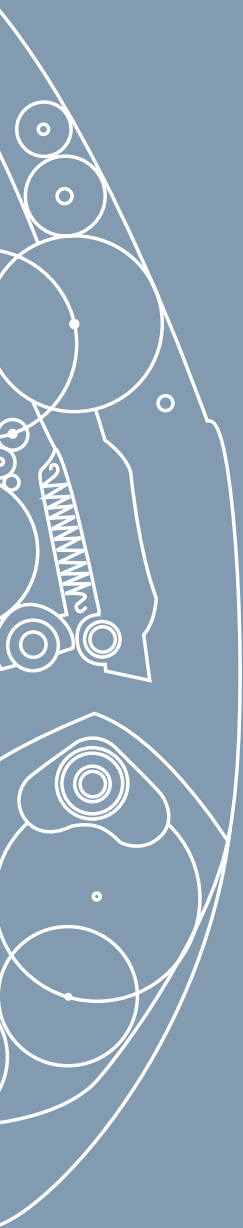

INTRODUCTION TO ACOUSTICS	5
THE AUDITORY SYSTEM	35
TYPES AND CAUSES OF HEARING LOSS	59
AUDIOMETRY	77
PROGRESS IN HEARING AID DEVELOPMENT	101
HEARING AID TYPES	119
HEARING AID COMPONENTS	135
SIGNAL PROCESSING	161
EARMOULD AND SHELLS FOR HEARING AIDS	195
SOUND AND HEARING INDEX	215

CORRESPONDENCE CAN BE ADDRESSED TO WIDEX@WIDEX.COM
COPYRIGHT 2007 WIDEX A/S. ALL RIGHTS RESERVED.

FIRST EDITION: 1994 • SECOND EDITION: 1995 • THIRD EDITION: 2007 • ISBN NO: 87-985233-9-2

A series of approximately seven thin, black, wavy lines that flow from the left side of the page towards the right. The lines are smooth and undulating, creating a sense of movement and depth. They are layered, with some appearing in front of others, and they all seem to originate from a common point on the left before diverging and then converging again towards the right.

[CHAPTER 1]

INTRODUCTION TO ACOUSTICS



CHAPTER 1

INTRODUCTION TO ACOUSTICS 7

Wavelength 9

Frequency 10

Example 10

Amplitude 11

Phase 12

HOW IS THE SOUND PRESSURE LEVEL MEASURED? 14

The decibel scale 14

Example 15

Decibel scale reference level 15

COMPLEX SOUND SIGNALS 18

Periodic sounds 20

Aperiodic sounds 21

SPEECH SIGNAL 22

Oscillogram 22

Spectrogram 23

Long-term average speech spectrum – LTASS 24

PROPAGATION, REFLECTION AND DIFFRACTION OF SOUND 25

Sound wave propagation in a free field 25

Reflection of sound waves 26

Diffraction of sound waves 28

Example: Head shadow effect 29

RESONANCE – ACOUSTIC AMPLIFICATION OF SOUND 29

Quarter-wave resonance 30

Helmholtz resonance 31

Standing waves 32

INTRODUCTION TO ACOUSTICS

This chapter deals with the physical aspects of sound. The study and science of sound is also known as acoustics. Acoustics describes the production, propagation and reflection of sound as well as the mathematical principles behind these phenomena.

Although sound can be propagated through all elastic media, including air, fluid, and bone tissue, it is practical to base an introduction to sound on propagation in air. In air, sound can be seen as vibrations of air molecules. Due to the elasticity of the air, the vibrations can be observed as pressure variations. These pressure variations are called the “sound pressure” and are perceived by the ear as sound.

Sound is pressure variations that propagate in an elastic medium. The magnitude of these pressure variations is called the sound pressure level, and the variations are perceived by the ear as sound. Note that sound cannot propagate in a vacuum, because of the absence of molecules to transmit the sound energy.

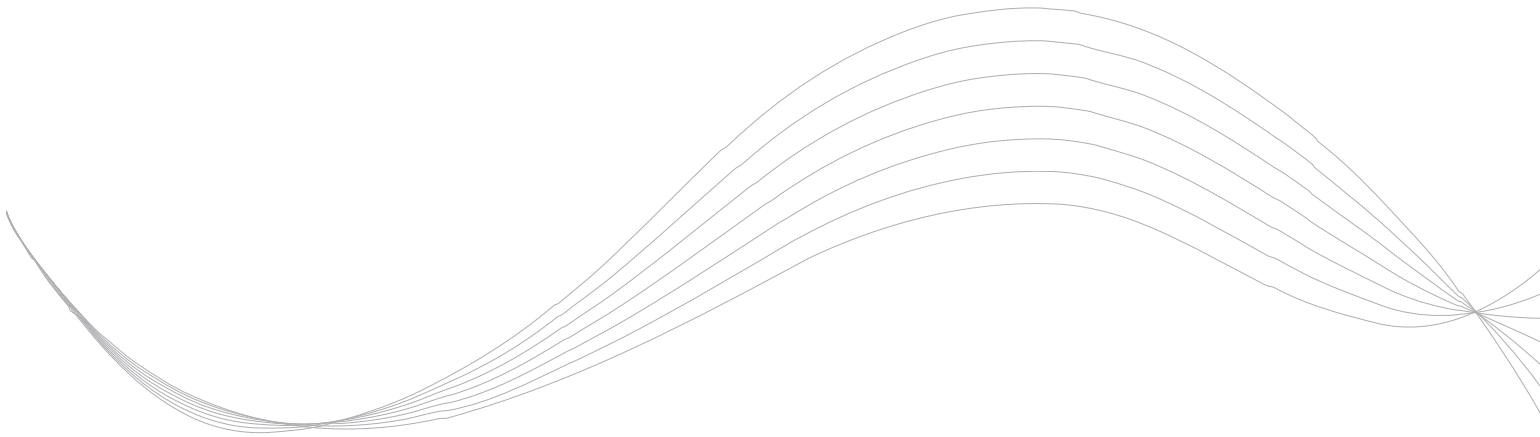

Sound can be illustrated by imagining a tuning fork struck against the edge of a tabletop. By doing so, the tuning fork is set in motion and starts to vibrate. The tines of the fork vibrate back and forth, repeatedly pushing the surrounding air molecules.

The air molecules also push each other, and thereby displace the neighbouring molecules before returning to their original position. This results in repeated condensation and rarefaction of air molecules, which spread as travelling waves. The vibrations of the tuning fork therefore spread through the air like a wave on the ocean (fig. 1.01).

The tuning fork is designed to create a pure-tone type sound at a certain pitch. When tuned to the concert pitch “A”, the tines of the tuning fork move back and forth 440 times per second, and thereby send out sound at a frequency of 440 cycles per second. When the sound waves reach the ear they make the eardrum vibrate and the sound is perceived as a steady tone.

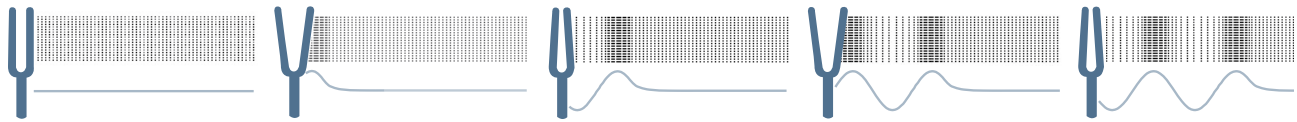

► Figure 1.01. The vibrations of the tuning fork result in a series of progressive sound waves. The air molecules push each other, passing the wave energy along.

When describing a pure tone with a certain pitch mathematically, the sine function is often used to illustrate the variation in sound pressure at a certain position, e.g. at the eardrum.

The part of the function above the x-axis corresponds to the condensation of the air molecules, while the part below corresponds to the rarefaction. In this way, the sine function illustrates how the pressure changes over time at a given place (fig. 1.02).

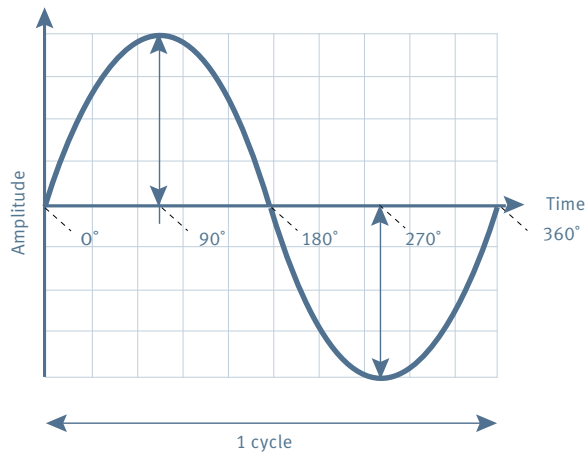

► Figure 1.02. The sine function is used to illustrate how the pressure changes over time at a given place.

On the basis of the sine function, the properties of a sound wave can be described according to the following concepts:

- Wavelength
- Frequency
- Amplitude
- Phase

Wavelength

The wavelength is the distance between repetitions in the sound pattern, e.g. the distance between two wave peaks. It is normally identified by the Greek letter lambda (λ), and measured in metres.

In air, a low tone will have a wavelength of several metres, while the wavelength of a high-pitch tone is only a few centimetres.

Frequency

The frequency is the number of times the pattern, or waveform, repeats itself in one second. Frequency is measured in Hertz (Hz) named after the German physicist Heinrich Hertz. In older literature, frequency is sometimes denoted c/s or cps, meaning cycles per second. Thus c/s corresponds to Hz.

For pure tones there is a mathematical relationship between the frequency and the wavelength of the sound wave. The frequency equals the speed of sound divided by the wavelength. Or in other words, the wavelength equals the speed of sound divided by the frequency.

$$\text{Frequency} = \frac{\text{Speed of sound}}{\text{Wavelength}}$$

or

$$\text{Wavelength} = \frac{\text{Speed of sound}}{\text{Frequency}}$$

Example

The speed of sound depends on air pressure, temperature and humidity. At the surface of the earth, the speed of sound is usually 340 metres per second. In the example with the tuning fork, sound waves propagate from the fork at a frequency of 440 Hz. This means the wavelength is 340 divided by 440, which equals 0.773 m (77.3 cm).

The lowest and the highest frequencies perceived by the human ear are in the areas of 20 Hz and 20,000 Hz, corresponding to wavelengths of 17 m and 0.017 m (1.7 cm). An individual with normal hearing can hear sounds within a frequency interval of approximately 20,000 Hz.

Frequency intervals are often described in octaves or decades. Both terms express the relationship between two frequencies. If one frequency is twice the other frequency, then the interval between them is one octave.

For example, the frequency interval from 100 Hz to 200 Hz is one octave. However, the frequency interval from 500 to 1000 Hz is also one octave, although the difference between these two frequencies is five times as big as in the former example.

Similarly, a decade denotes a frequency interval where the highest frequency is ten times larger than the lowest, for example 200 to 2000 Hz.

If the frequency of one tone is twice as high as that of the other, the interval between them is called an octave. If the frequency of one tone is ten times higher than that of the other, the interval between them is called a decade.

Amplitude

The maximum displacement of the sine function is called amplitude. It expresses the magnitude of the pressure variations that the condensation and rarefaction of the air molecules produce compared to normal air pressure. The amplitude represents the sound pressure of the wave. Two sine waveforms that are identical in wavelength and frequency but vary in amplitude represent two different sound pressure values. The higher the amplitude, the higher the sound pressure (fig. 1.03).

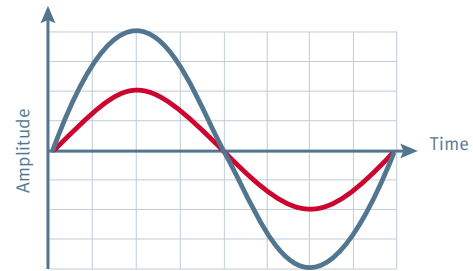

► Figure 1.03. Two sine waveforms that vary in amplitude; one is twice as high as the other. The sound pressure for the waveform with the highest amplitude is twice as large as the sound pressure for the other waveform.

Phase

The phase indicates the starting point on the waveform. This is expressed in degrees, from 0 to 360, and is called the phase angle. The phase angle is typically used to describe the relationship between two pure tones that have the same frequency and amplitude, but vary in their starting phase. This phase difference affects the total amplitude of the two pure tones.

If the phase difference is 0 degrees, the starting phase of both waveforms is 0 degrees and the total amplitude is the sum of both amplitudes (fig. 1.04).

If the phase difference is 90 degrees, the starting phase of one waveform is 90 degrees while the starting phase of the other waveform is 0 degrees. In this case the total amplitudes are out of phase and the sound pressure varies accordingly.

If the phase difference between two waveforms is 180 degrees, the starting phase of the first waveform is at 0 degrees and the starting phase of the other waveform is at 180 degrees. In this case the amplitudes neutralise each other and the sound pressure is reduced accordingly.

Phase difference means that if two loudspeakers send out identical pure tones, they create a total sound pressure which may vary at different positions in the room, from twice the sound pressure from one loudspeaker to no sound pressure at all (fig. 1.04).

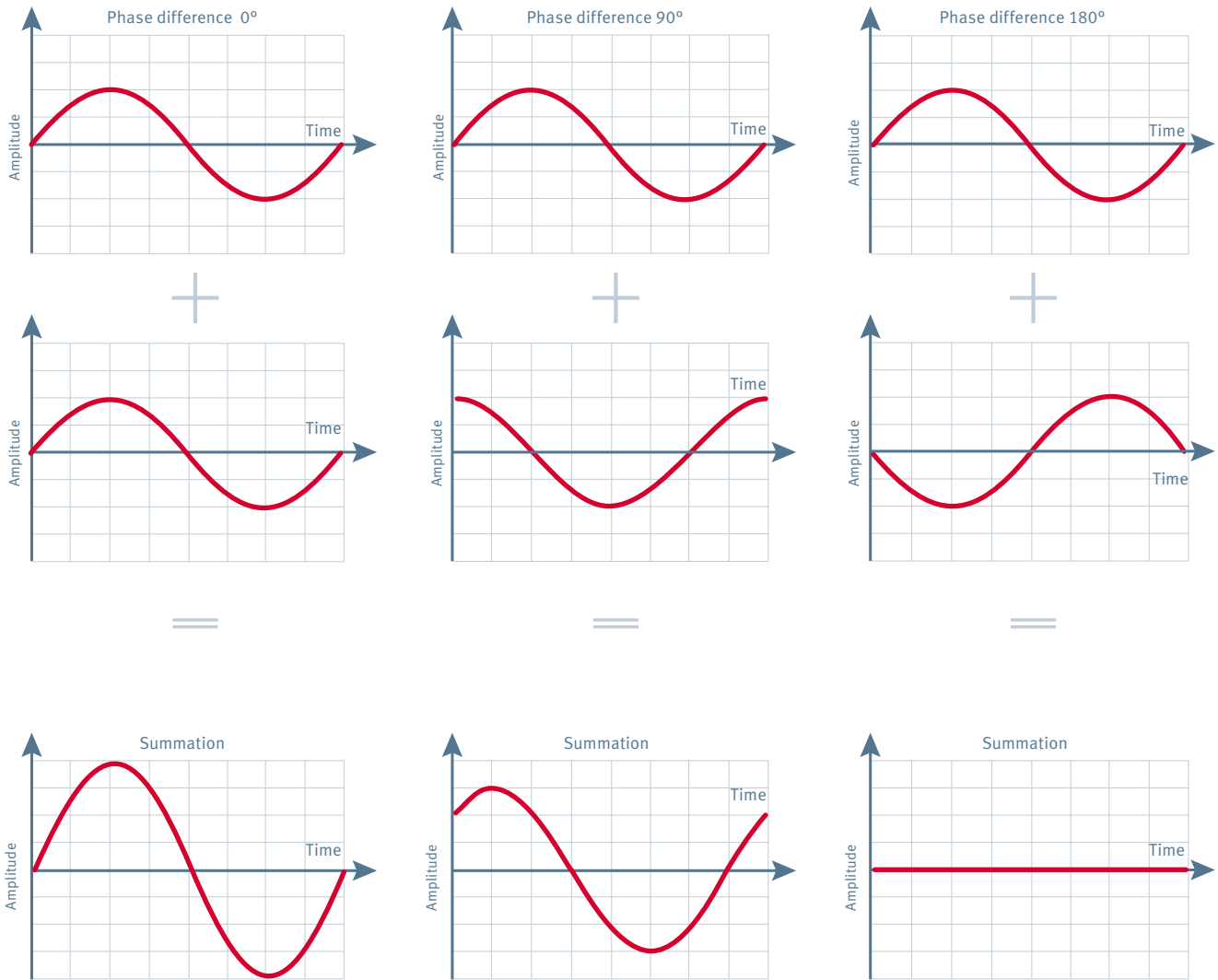

▷ Figure 1.04. The effect of a phase difference of 0, 90 and 180 degrees on the total amplitude for three waveforms.

HOW IS THE SOUND PRESSURE LEVEL MEASURED?

Pressure is defined as force exerted per unit area and is expressed in Pascal (Pa). Because of the often low numerical values in acoustics, the sound pressure is also expressed in micro Pascal (μPa), for example $20 \mu\text{Pa}$ instead of 0.00002 Pa . For comparison, the atmospheric pressure is about $100,000 \text{ Pa}$.

$20 \mu\text{Pa}$ is the lowest sound pressure that can be heard by the human ear, when the sound is a pure tone with a frequency of around 2000 Hz . At the other end of the scale, where the sound is uncomfortably loud, the sound pressure is around $20,000,000 \mu\text{Pa}$, which is one million times greater than the softest audible sound. The large sound pressure variations make it difficult to use micro Pascal to describe different sound levels. Therefore the decibel scale was introduced.

The decibel scale

When developing the telephone network, a unit for sound pressure levels was required that was more manageable and that better matched the sound level perception of the ear. A logarithmic scale was introduced; its units are called decibels (dB) – named after the inventor of the telephone, Alexander Graham Bell.

The unit of decibel (dB) indicates the relative difference between two sound pressures. First the relationship between the two sound pressures is measured. Then the decimal logarithm of this relationship is calculated, and the result is multiplied by 20.

$$\text{dB sound pressure} = 20 \log \frac{\text{Current sound pressure}}{\text{Reference sound pressure}}$$

Example

The ratio between two sound pressure values of 20,000 μPa and 200 μPa , respectively, is 100:1. The logarithm of 100 is 2, and the difference between the two sound pressure values is 2 times 20, which equals 40 dB. The one sound is 40 dB higher than the other sound.

The unit of decibel (dB) indicates the relative difference between two sound pressures.

Because the decibel scale is logarithmic, the large difference from 20 to 20,000,000 μPa is converted into the more manageable value of 120 decibel.

Decibel scale reference level

A sound pressure expressed in decibels says something about the relative difference between two sound pressures. A sound may, as illustrated above, be 40 dB higher than another sound. To indicate the absolute sound pressure it is necessary to provide information about the reference level for the zero point.

The absolute sound pressure is denoted decibel sound pressure level (dB SPL). The reference of the sound pressure level is set at the lower limit of human hearing ability, which is 20 μPa .

Thus, 0 dB SPL corresponds to a sound pressure of 20 μPa , and a sound pressure level of, for example, 40 dB SPL corresponds to a sound pressure that is 40 dB above the reference level of 20 μPa . Typically, soft speech has a sound pressure level in the order of 40 dB SPL.

dB SPL indicates the sound pressure level, that is by how many decibels the sound pressure exceeds the reference pressure of 20 μPa .

Sound pressure levels are measured with a sound level meter. A sound level meter has a microphone that measures the size of the pressure variations in the propagating sound wave.

The sound pressure levels of the sounds in our environments generally lie on a scale from 0 dB SPL to around 120 to 140 dB SPL. The table below provides examples of the sound pressure level for different sound types (fig. 1.05).

SOUND SOURCE	TYPICAL SOUND PRESSURE LEVEL
Rustling leaves	Around 10 dB SPL
Living room	50 dB SPL
Ordinary conversation	65 – 70 dB SPL
Industrial noise	Around 85 dB SPL
Rock concert	Around 110 dB SPL
Pain threshold for the ear	Around 120 dB SPL
Sound of a jet motor	130 – 140 dB SPL

There are other concepts besides the sound pressure level that can be used together with a decibel scale for audiological and audiometric measurements. These are described in other chapters in this book.

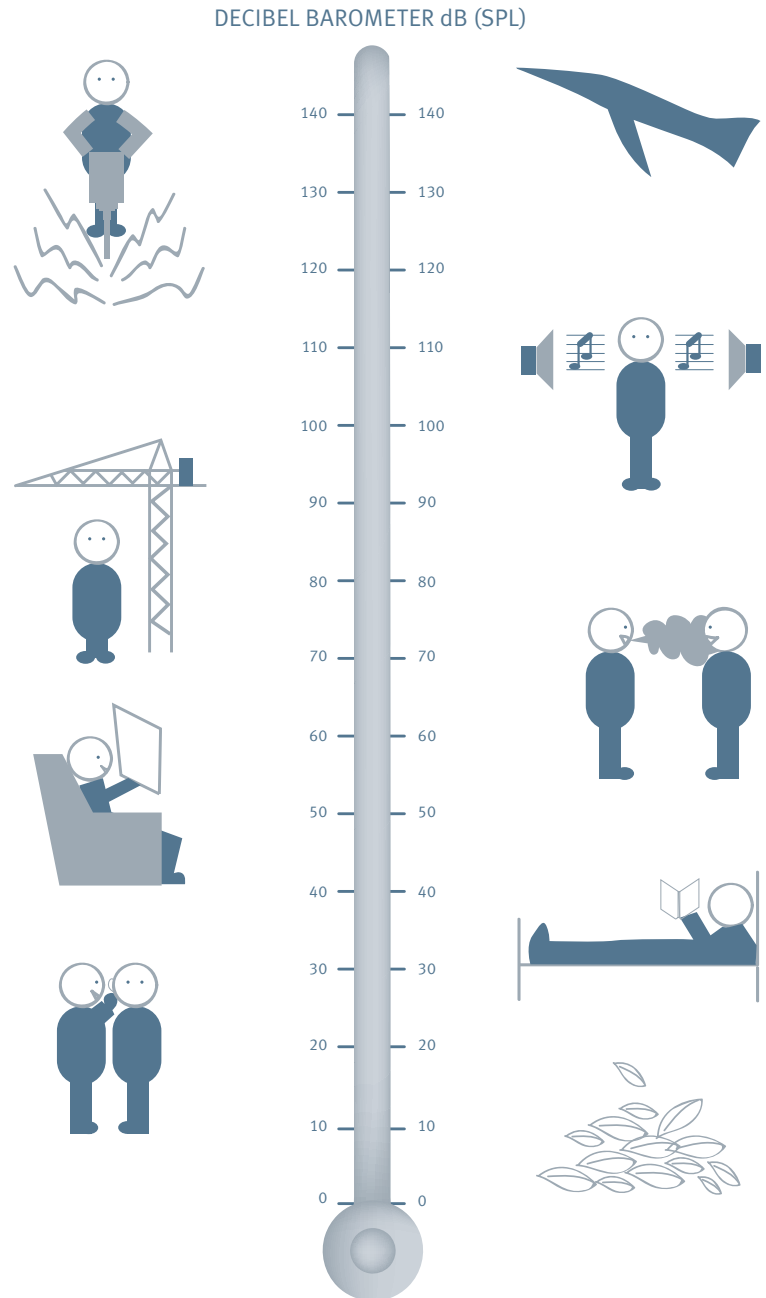

► Figure 1.05. Decibel barometer with typical sound pressure levels.

COMPLEX SOUND SIGNALS

Pure tones are very rare in our surroundings. They can only be produced by electronic equipment such as a tone generator in a mobile phone. The sounds we hear in daily life, like the sound coming from a musical instrument, car engine or someone speaking, are much more complex.

The French mathematician Jean-Baptiste-Joseph Fourier found out that any complex sound can be considered as a collection of pure tones. He invented a mathematical tool that can determine the frequency components of a complex sound. This tool is known as the Fourier Transform, also called a spectral analysis (fig. 1.06).

The frequency components of a complex sound can be established by a Fourier Transform, which is also called a spectral analysis.

Complex sounds are grouped in two categories:

- periodic sounds
- aperiodic sounds

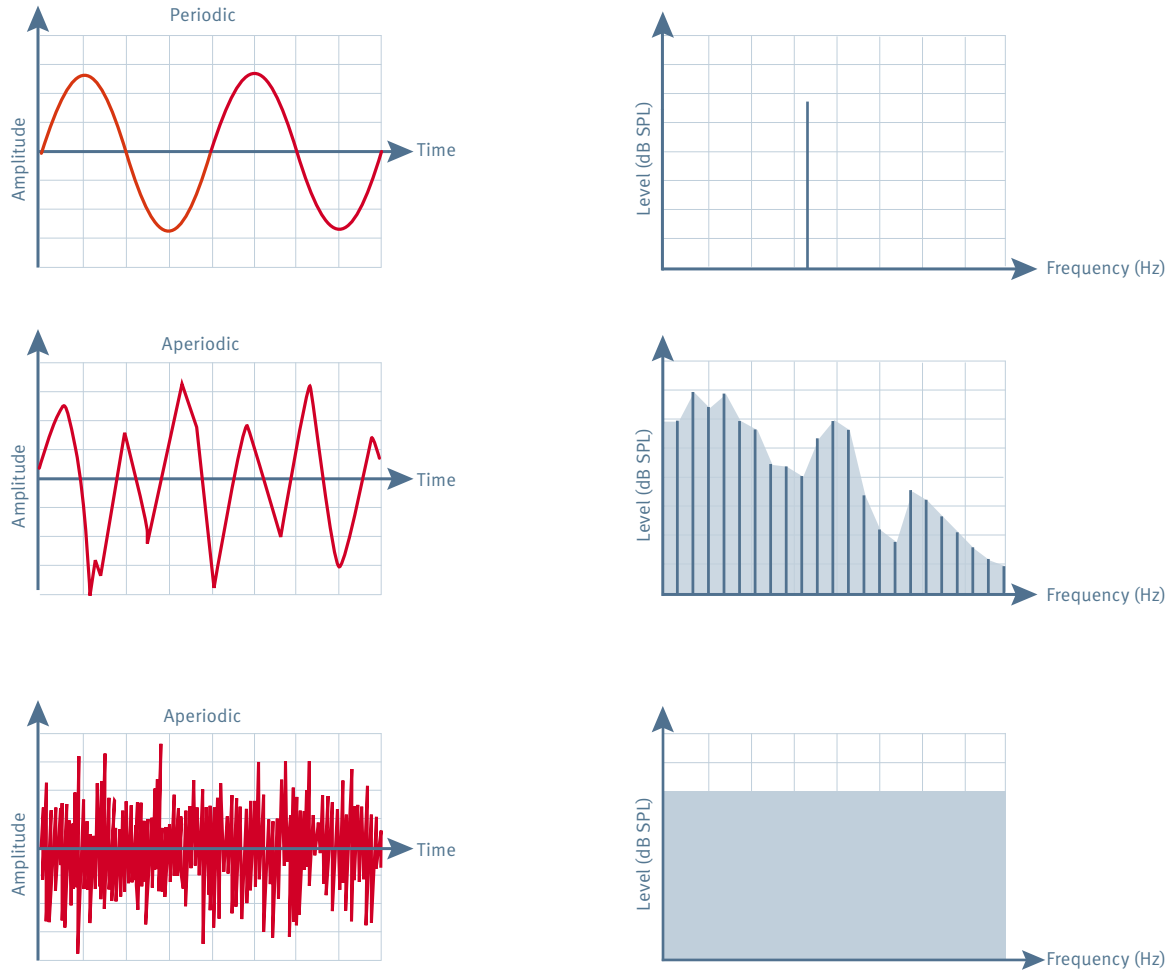

► Figure 1.06. The spectrum of a sound signal shows the frequency components of the complex sound within a given time interval. The example shows a spectral analysis of three different sounds – at the top a pure tone, in the middle a vowel sound and at the bottom a noise signal.

Periodic sounds

Similarly to pure tones, periodic complex sounds are characterised by a repeated wave pattern with a specific wavelength. However, contrary to the regular waveform of a pure tone, the complex sound has a more irregular and edged waveform. An example of a periodic complex sound is the tone generated by a wind instrument, for example an oboe.

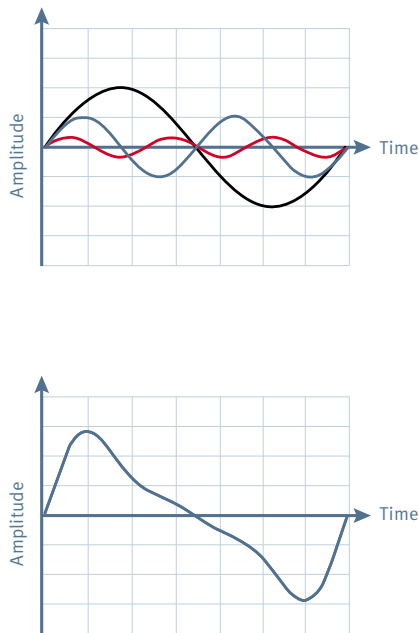

▶ Figure 1.07. Example of a periodic sound composed of three frequencies. The added waveform is shown below.

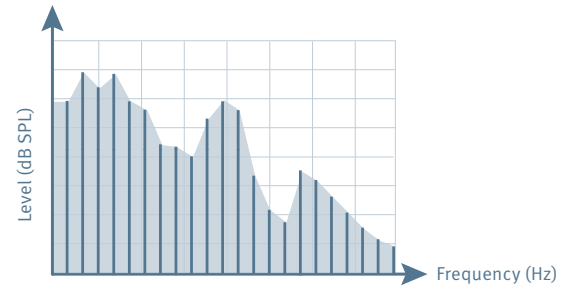

▶ Figure 1.08. Line spectrum of the periodic sound from an oboe playing the tone A.

The spectrum of a periodic sound consists of the principal frequency of pattern repetition, which is also called the fundamental frequency. The other frequency components of sound are known as overtones or harmonics. The frequencies of the overtones are multiples (2, 3, 4 etc.) of the fundamental frequency of the sound (fig. 1.07).

An example is when an oboe or a trumpet plays a long sustained tone, for example the tone A with 440 Hz as its fundamental frequency. The frequencies of the harmonic overtones will then be 880 Hz, 1320 Hz, 1760 Hz etc. (fig. 1.08).

The reason why we can distinguish the sound of the oboe from the trumpet is that the sound level of the individual overtones is not the same in the two instruments, which results in a different tonal quality.

Aperiodic sounds

The other group of complex sounds, aperiodic sounds, have a wave pattern that is not repeated and its wavelength and waveform change over a period of time. Examples of aperiodic sound include the rustling of leaves on the trees or impulse sounds such as the bang of a slamming door (fig. 1.09).

The frequency composition of aperiodic sounds can also be determined by a spectral analysis.

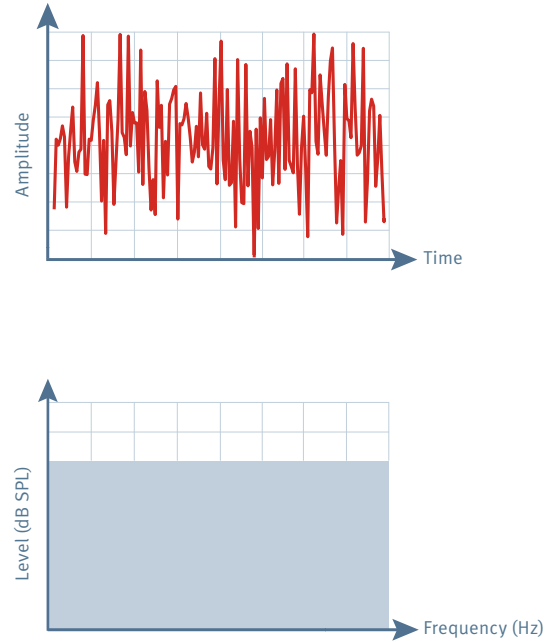

► Figure 1.09. Wave pattern of a complex aperiodic sound and the associated spectral analysis. This type of noise contains all frequencies and is named white noise after white light, which in a similar way contains all the frequencies of light.

SPEECH SIGNAL

Speech consists of connected quasi-periodic and aperiodic sounds. Some speech sounds are formed in the throat (voiced), where the vocal chords vibrate in response to the outgoing air flow, causing the air in the throat and oral cavity to vibrate. Other sounds are noise sounds which are generated when air passes through narrow passages (unvoiced), for example between the lips.

Speech consists of quasi-periodic and aperiodic sounds.

When a person speaks, his or her tongue, lips and jaw constantly change position. When this happens, the resonance in the oral cavity also changes, providing the different speech sounds with their unique tonal quality. This is called articulation.

The acoustic properties of a speech signal can be viewed in several ways. We are going to look at three ways:

- oscillogram
- spectrogram
- long-term spectrum

Oscillogram

The oscillogram shows how the amplitude of the speech signal varies as a function of time. From the oscillogram, we recognise the aperiodic and quasi-periodic wave pattern that occurs as a person pronounces the individual words (fig. 1.10).

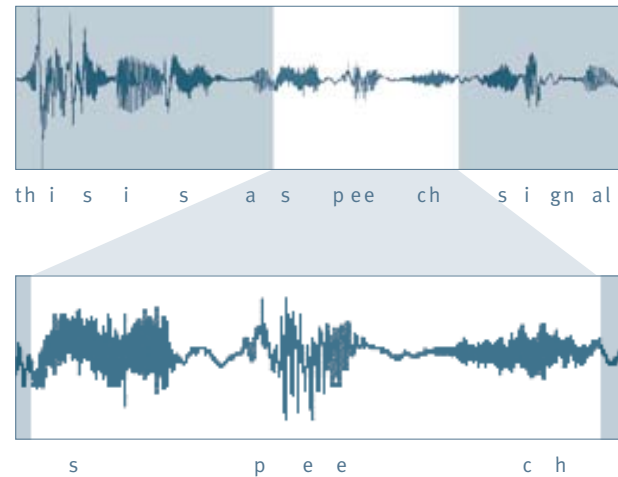

► Figure 1.10. Oscillogram of the sentence “This is a speech signal”. If we look at the word “speech”, it can be seen how the consonants, first /s/ and /p/ and last the /ch/ sound result in an aperiodic wave pattern. The /e/ vowel in the middle of the word shows a quasi-periodic waveform.

Spectrogram

A more detailed presentation of the properties of the speech signal can be obtained by recording a spectrogram. Time is shown on the horizontal axis, as in the oscillogram. The vertical axis represents frequency, and the darkness of the tracing indicates the sound level. The spectrogram shows how speech consonant sounds and vowel sounds alternate in a given period of time (fig. 1.11).

The spectrogram gives information about how the individual speech sounds change over time.

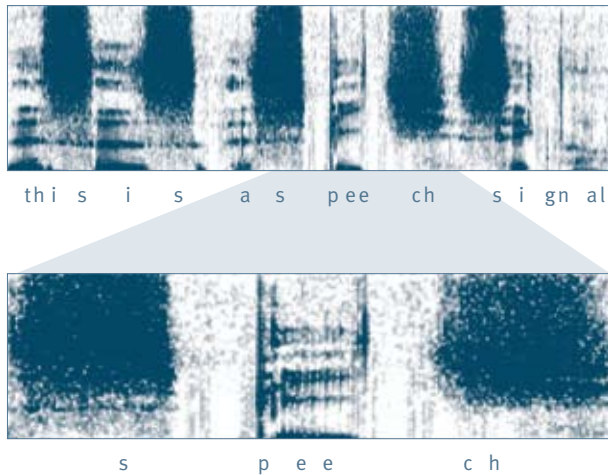

► Figure 1.11. Spectrogram of the sentence “This is a speech signal”.

Looking at the word ‘speech’ again, we first find the aperiodic noise from the /s/ sound. The noise is produced by turbulence created when air passes through the narrow passage between the tip of the tongue and the inside of the teeth in the upper part of the mouth.

The /s/ sound is followed by a pause, during which a pressure of air is created behind the shut lips. The air pressure is released as an explosive noise that constitutes the /p/ sound just before the vowel sound.

The /e/ vowel is generated via the periodic vibrations of the vocal chord. It is characterised by a number of almost horizontal stripes distributed across the frequency spectrum. These stripes represent the formants, and are groups of partial tones amplified due to resonance in the throat and oral cavity.

The form of the throat and the opening of the mouth change continuously as we pronounce different consonants and vowels. As a result, the resonance conditions change, which can be seen from the way the formants move up or down in the frequency spectrum – the so-called formant transitions. The formants are very important for the perception of speech sounds.

At the end of the word ‘speech’ we find the /ch/ sound, which is generated in a similar way as the /s/ noise.

Long-term average speech spectrum – LTASS

Another way of illustrating the speech signal is by measuring the average spectrum for a long speech signal, for example when a person reads out loud from a newspaper article. The result is a long-term average speech spectrum that shows how the energy of speech is distributed across the frequency spectrum. The abbreviation of Long Term Average Speech Spectrum is *LTASS* (fig. 1.12).

A long-term average speech spectrum shows how the energy of speech is distributed across the frequency spectrum on average.

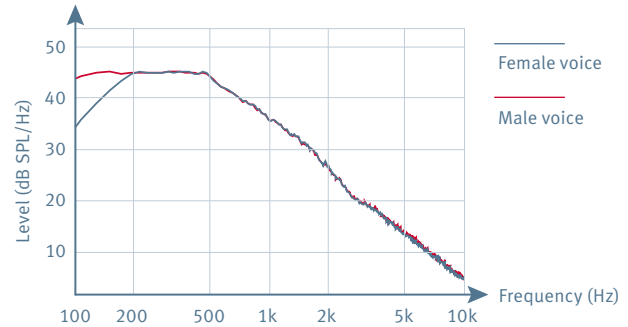

► Figure 1.12. Long-term average speech spectrum in men and women with ordinary voice intensity. The long-term speech spectra of men and women differ in the lower frequency range. The fundamental frequency of men is generally lower (approx. 100-150 Hz) than that of women (about 200-300 Hz).

At normal voice intensity, the LTASS typically has most energy at low frequencies, and gradually less energy at higher frequencies. This reflects how the energy-rich vowels of speech are positioned in the low- and mid-frequency regions whereas the lower-energy consonants lie in the high-frequency region.

PROPAGATION, REFLECTION AND DIFFRACTION OF SOUND

When a stone is thrown into the water, we see surface waves spreading in circles. The way sound waves propagate in air is very similar to the spreading of surface waves in water (fig. 1.13). A significant difference, however, is that sound waves in air propagate from the source in all three dimensions, like an expanding sphere.

Three different situations are described in the following sections:

- Sound wave propagation in a free field
- Reflection of sound waves
- Diffraction of sound waves

Sound wave propagation in a free field

In a free sound field, the sound waves propagate undisturbed in all directions. The further the distance from the sound source, the larger the area over which the sound energy spreads, and the lower the sound pressure.



▶ Figure 1.13. The propagation of sound waves in a free field can be compared with the spreading of waves in water. However, in air, the sound propagates to all sides like an expanding sphere.

The sound pressure level is reduced by fifty percent when the distance from the sound source is doubled, corresponding to an attenuation of 6 dB. This fact is referred to as the inverse square law.

The inverse square law: The sound pressure level is reduced by 6 dB when the distance from the sound source is doubled.

Reflection of sound waves

Sound waves seldom propagate freely in space. There are usually boundaries or objects disturbing the propagation. When sound waves hit an object, for example a wall, part of the sound wave energy is thrown back from the wall. This is called reflection and can be compared with the reflection of light from a mirror (fig. 1.14).

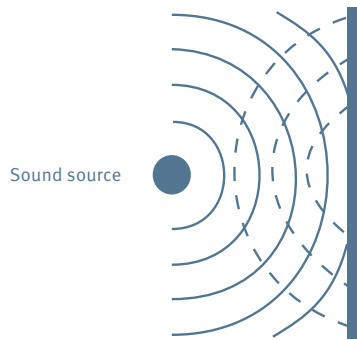

▶ Figure 1.14. Sound waves are reflected from a plane surface.

The degree of reflection depends on the surface material. A hard wall reflects much of the sound wave energy, whereas a wool rug on the wall absorbs part of the sound wave energy, thereby reducing the reflections. A minor part of the sound wave energy may also be transmitted through the wall, for example when the sound from a stereo can be heard in the adjoining room.

A typical example of reflection is the sound of the echo heard when you yell towards the hillsides of a valley. Due to the long distance, it can take relatively long before the echo of your voice comes back.

Another example is the echoing sound of words spoken in a large room, such as a church. Shortly after a word has been pronounced, reflections of the word bounce back from the walls of the room. When the reflections follow each other at short intervals, it is perceived as a prolonged sound which is slowly absorbed.

This phenomenon is known as reverberation.

Reverberation time is defined as the number of seconds that pass from the sound source stopping until the sound pressure level has decreased by 60 dB.

The reverberation time depends on the extent to which the sound wave energy is absorbed by the walls, and whether there are people, furniture, carpets or other objects in the room to further reduce the reflections.

The acoustic properties of a room are often tailored to the function of the room. Concert halls are typically designed for a long reverberation time of up to several seconds to add sonorousness to the music. In school classrooms the reverberation time should be just long enough to permit the voices of the teacher and students to be heard clearly everywhere in the room. The reverberation time in living rooms is often rather short, typically less than one second (fig. 1.15).

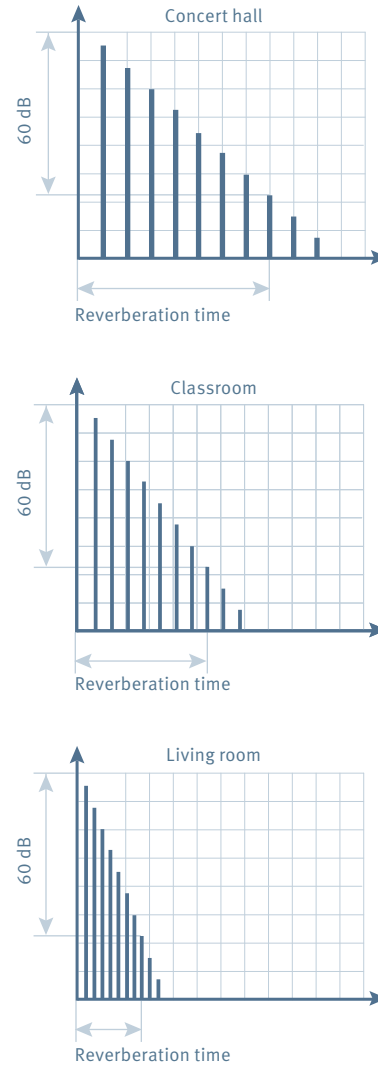

► Figure 1.15. The reverberation time varies according to the acoustic properties of the room.

Diffraction of sound waves

Sound is able to bend around corners or continue through narrow passages. This phenomenon is called diffraction and is something we experience daily, for example when hearing the sound of an ambulance before it comes around the corner.

Diffraction is the bending or changing of the direction of sound waves around an object in the sound field or through a narrow passage.

Diffraction occurs because of an individual air molecule's ability to push against the neighbouring molecules. Air consists of many molecules. When a group of air molecules are affected by the propagating sound wave, the air molecule movement spreads to the air molecules nearby – not only in the direction of the propagating wave, but also in the adjacent directions. In this way, sound can spread around an object in the sound field or through a passage in a wall (fig. 1.16).

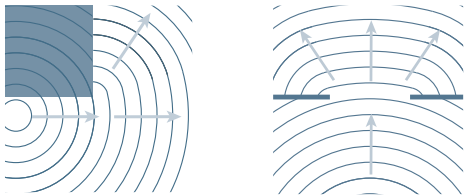

► Figure 1.16. Sound can propagate around corners or through passages.

The effect of diffraction depends on the size of the object obstructing the sound compared to the wavelength of the sound. If the object is smaller than the wavelength, the waves continue almost undisturbed on the other side of the object. If the object is larger than the wavelength, the sound waves will, to a greater extent, be reflected from the object, and a sound shadow will be produced on the back of the object (fig. 1.17).

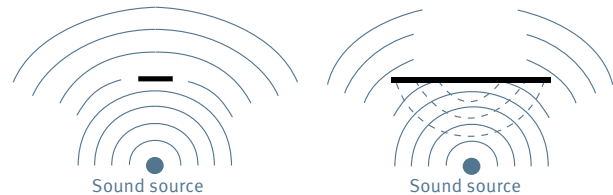

► Figure 1.17. A small and a large object positioned in the direction of the propagating sound wave. The large object reflects the sound waves more.

Example: Head shadow effect

An example of this phenomenon is the head shadow effect. Sound waves with a wavelength that is shorter than the diameter of the head (i.e. high frequencies) are attenuated from one side of the head to the other due to their reflection from the head. Sound waves with a wavelength that is larger than the diameter of the head (i.e. low frequencies) will propagate almost unchanged to the opposite side of the head.

The auditory system uses the information about the low-frequency phase differences and high-frequency sound level differences at the two ears to localise a sound source.

RESONANCE – ACOUSTIC AMPLIFICATION OF SOUND

A weak sound source may under certain circumstances produce a very high sound level – a phenomenon referred to as resonance. Resonance occurs when the relationship between the geometry of an air-filled space (e.g. a cavity or a room) and the frequency of the sound waves propagating through this space fulfills specific conditions.

Some musical instruments take advantage of the resonance effect. When a trombonist plays another tone on the instrument by changing the length of the tubing, he or she changes the resonance in the trombone. You can experiment with resonance in a small bathroom. When you sing at a certain pitch, it may feel as if your voice resonates throughout the entire room.

Quarter-wave resonance

One resonance type is especially important in the audiological world. The type referred to is the quarter-wave resonance, which occurs in a tube or channel that is open at one end and closed at the other, just like the ear canal in the human ear. The resonance is at the frequency at which the tube length amounts to one quarter of the wavelength of the sound.

The adult ear canal is approx. 3 cm long, and it is open at one end and closed at the other end at the eardrum. This means that sound waves with a wavelength of four times the length of the ear canal – approximately 12 cm – will be amplified. A wavelength of 12 cm corresponds to a frequency of approx. 2800 Hz. In the region around this frequency the sound signal will be amplified at the eardrum by approx. 10 to 15 dB (fig. 1.18). This effect is known as ear canal resonance.

The ear canal resonance for adults is around 2800 Hz and results in the amplification of the sound signal at the eardrum of 10 to 15 dB around this frequency.

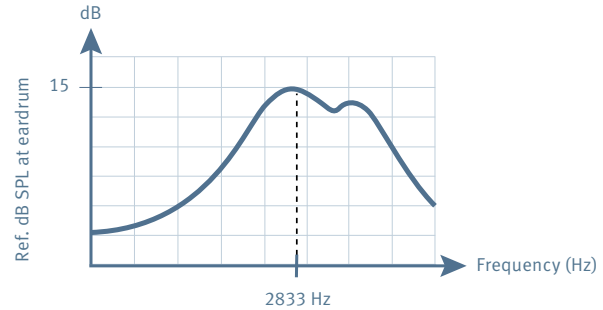

$$\text{Frequency} = \frac{\text{Speed of sound}}{\text{Wavelength}} = \frac{340 \text{ m/s}}{0.12 \text{ m}} = 2833 \text{ Hz}$$

► Figure 1.18. The ear canal creates amplification as a result of the quarter-wave resonance. The example in the illustration applies to an ear canal length of 3 cm. The y-axis shows the sound pressure level at the eardrum relative to the sound pressure outside the ear.

The ear canal of a newborn child is shorter and has a smaller volume than the adult ear canal. The ear canal resonance will consequently be greater and shifted to higher frequencies, to around 5-6 kHz. At the age of five years the child's ear canal has grown so much that its resonance effect reaches adult values.

Helmholtz resonance

Another important type of resonance is named after the German scientist Hermann von Helmholtz. This type of resonance results from the combination of a cavity and a tube.

A classic example is the deep tone that is produced when you blow across the neck of an empty bottle. The air pressure created by your mouth presses the air column in the bottleneck downward, thereby increasing the pressure in the bottle. Due to the elasticity of the enclosed air, the air column will be pressed up through the bottle neck and then be pressed down again by the air pressure from your mouth and so on. In this way, the air column is set into vibration and a low-frequency tone is generated.

The Helmholtz resonance is a well-known phenomenon in audiology, where it occurs in the earmould, which conducts sound from the hearing aid into the ear. If the earmould is provided with a vent, the ear-canal cavity is connected to the atmosphere outside the earmould. The earmould and ear canal function as a Helmholtz resonator, providing a small degree of amplification of the sound in the ear canal at a certain frequency. The resonance frequency is at around 500 Hz, depending on the size of the vent in the earmould.

Standing waves

Standing waves occur when two sound waves of the same frequency and amplitude travel in opposite directions. This is the case when a sound wave is reflected back and forth between the walls in a room. The sum of the two waves results in a standing wave. Standing waves are characterised by the fact that there are certain points in the room where the air molecules do not move – called nodes. Instead, the air molecules are compressed resulting in a high sound pressure. At other points in the room, there is great air particle activity – called antinodes – where the air particles are more dispersed and the sound pressure is consequently low.

Nodes occur where the phase difference between the two sound waves is 180 degrees, while antinodes occur at points where the phase of the two sound waves is the same.

In a room with standing waves, the sound pressure may vary noticeably from one place to another. Usually the sound pressure will be largest in the corners of the room and close to the walls – where the sound energy is most concentrated in the nodes (fig. 1.19).

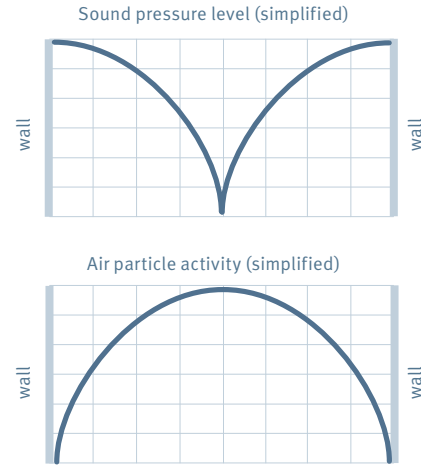

► Figure 1.19. The principle of standing waves; there are points where the air molecules are practically standing still (node and a high sound pressure), while at other points the activity of the air molecules is large (antinode and a low sound pressure).

In sound-treated rooms, such as an audiometric test booth, standing waves do not occur to the same extent, but are often present at lower frequencies. The reason for this is that the sound-absorbing materials covering the walls are typically far less effective in the low frequency range.

The quarter-wavelength resonance can be explained from standing waves, since the incoming wave reflects at the closed end, and adds to itself, thus creating a standing wave. At the resonance frequency, a small pressure at the open end (the node) is amplified to a larger pressure at the closed end (the antinode), as is the case with the ear canal resonance.

A series of seven thin, light gray wavy lines that flow from the left side of the page towards the right, creating a sense of movement and depth. The lines are layered, with some appearing in front of others, and they all converge towards the right edge.

[CHAPTER 2]
THE AUDITORY SYSTEM



CHAPTER 2

THE AUDITORY SYSTEM 37

OUTER EAR 38

Auricle 38

Ear canal 39

Ear canal resonance 40

MIDDLE EAR 41

Anatomy of the middle ear 41

Stapedial reflex 42

INNER EAR 43

Anatomy of the cochlea 44

Organ of Corti, hair cells and stria vascularis 46

Travelling wave on the basilar membrane 48

Function of the inner and outer hair cells 49

Transmission of information to the auditory nerve 49

Central auditory nervous system 50

PSYCHOACOUSTICS 51

Measuring the hearing threshold 51

Establishing hearing thresholds by the ascending method 52

Audible range 53

Perception of loudness 54

Frequency and temporal discrimination 55

Masking 55

THE AUDITORY SYSTEM

This chapter describes the anatomy of the human ear and how sound waves move through the ear. The section on psychoacoustics describes how hearing thresholds can be measured and how the human ear perceives loudness, frequency and temporal resolution.

The hearing system consists of three sections; the outer ear (1 • auris externa) with the visible portion of the ear and the ear canal, the middle ear (2 • auris media) with the ossicles and the tympanic membrane, and the inner ear (3 • auris interna) with its fluid-filled spaces.

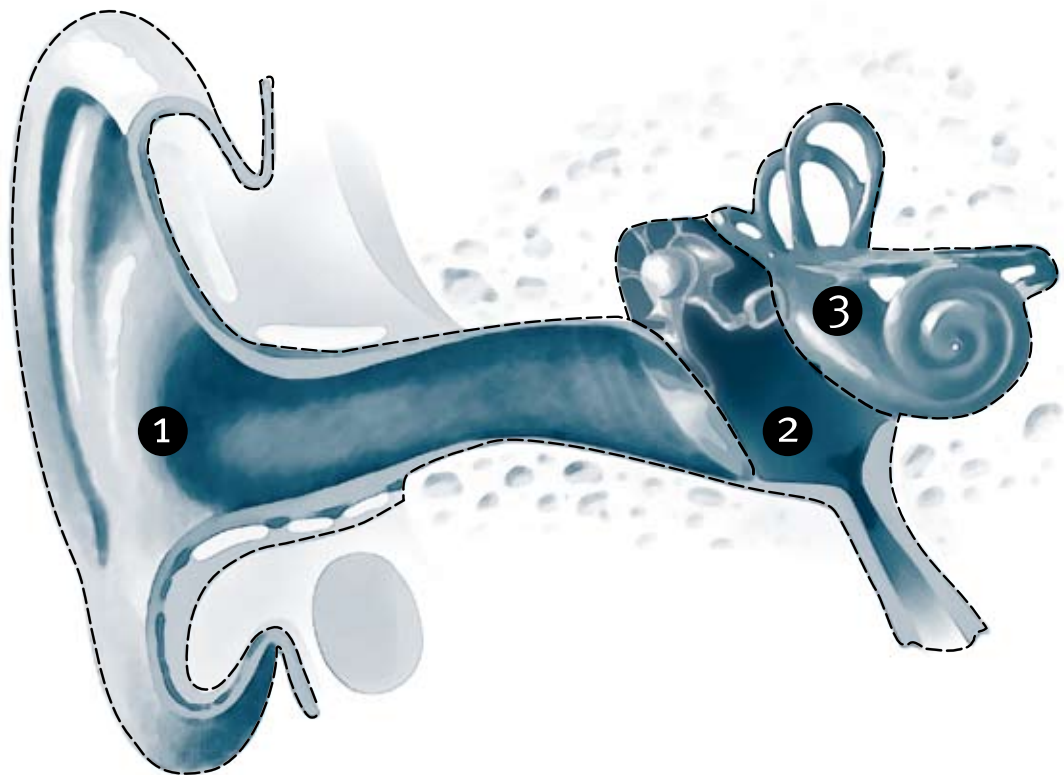

OUTER EAR

The outer ear includes the auricle (pinna) and the ear canal (fig. 2.01).



► Figure 2.01. The outer ear with the auricle and ear canal.

Auricle

The auricle consists of cartilage and skin; it sits at an angle of approx. 30 degrees from the head and is the only visible portion of the ear (fig. 2.02).

The funnel shape of the auricle is important for sound source localisation

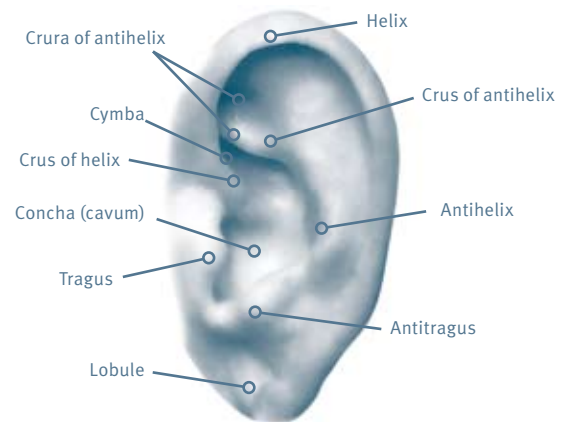

► Figure 2.02. The auricle with anatomical landmarks.

Ear canal

The ear canal directs sound to the eardrum (tympanic membrane). It usually has two bends, which gives it almost the shape of an s (fig. 2.03).

The outer part of the ear canal consists of cartilage covered by skin, which has hair and glands. The glands produce ear wax (cerumen). Ear wax serves to keep the ear canal moist and helps to migrate dead skin particles out of the ear canal. It also protects the eardrum and the middle ear from intrusion by foreign objects. The inner part of the ear canal, which takes up a third of the ear canal length, extends from the second bend to the eardrum. This part of the ear canal is hard and bony. It is covered only by a thin layer of skin, which makes it very sensitive to touch.

The ear canal is movable. When we chew and move our jaws, the walls of our ear canals move, causing a change of the cross section shape. This is very important for the production of hearing aids and earmoulds, which must sit correctly in the ear.

The ear canal collects sound. The outer section of the ear canal consists of cartilage covered by hair and glands, which produce ear wax. The inner section is hard and bony.

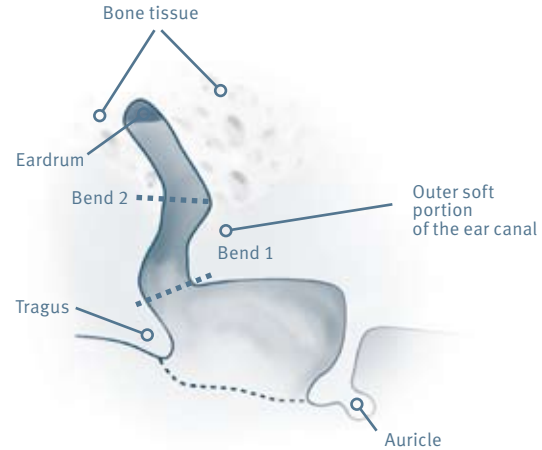

► Figure 2.03. Cross section of the outer ear and the ear canal, seen from above. The ear canal, which extends from the outer ear to the eardrum, usually has two bends. The first bend is located at the bottom of the concha, and the second bend is located where the soft and the hard portions of the ear canal meet.

Ear canal resonance

As mentioned in the chapter “Introduction to acoustics”, the ear canal also acts as a resonator. The ear canal is oblong and closed at one end, so sound waves with a wavelength corresponding to four times the length of the ear canal are amplified. The amplification from the ear canal resonance amounts to approx. 10-15 dB, and the average adult resonant frequency is approximately 2.8 kHz (fig. 2.04).

The volume of the ear canal, and consequently its acoustic characteristics, varies individually and according to age. The ear canal volume of newborn babies is about 0.5 cubic centimetre. At around the age of five years, the child’s ear canal has grown to its final volume of approx. 1.3 cubic centimetres.

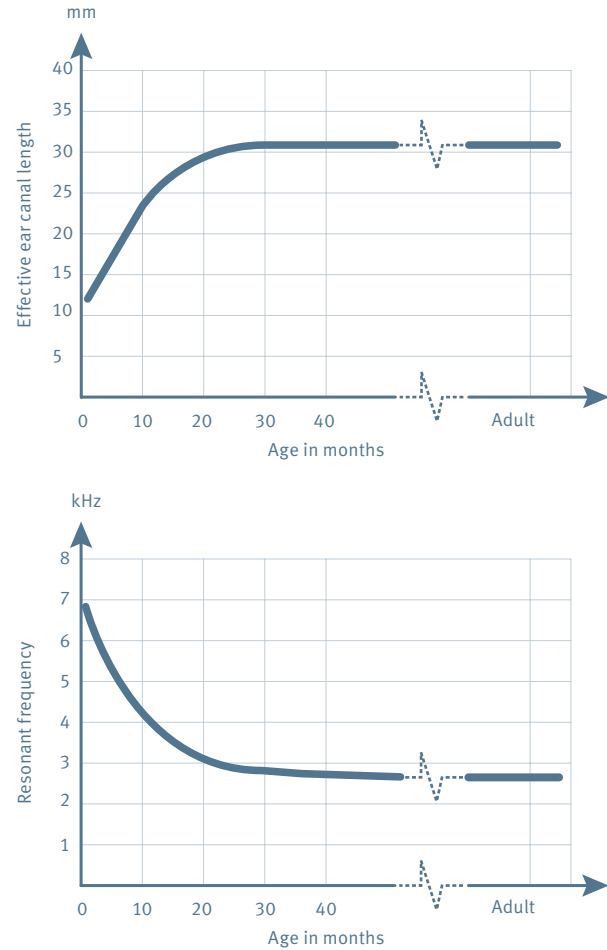

► Figure 2.04. The average adult resonant frequency of the ear canal is about 2.8 kHz. It varies according to the individual ear canal volume.

MIDDLE EAR

The middle ear is located in one of the hardest bones of the body, i.e. the temporal bone, and is usually filled with air. The middle ear air pressure is equalised to ambient air pressure by the Eustachian tube, which connects the middle ear with the back of the throat and the nose (fig. 2.05).



► Figure 2.05. The middle ear is located in the temporal bone, between the outer ear and the inner ear.

Anatomy of the middle ear

The middle ear cavity houses the ossicles. These are three small bones that are known as the malleus, incus and stapes. They are connected in joints. The handle of the malleus is embedded in the eardrum, and the stapes footplate is attached to the oval window of the inner ear (fig. 2.06).

The ossicles form a chain which transfers the mechanical energy of the sound waves from the eardrum to the fluid-filled cavities of the inner ear.

The ossicles and the area difference between the tympanic membrane and the stapes footplate act as levers when transmitting the mechanical energy of the sound waves to the fluid in the inner ear.

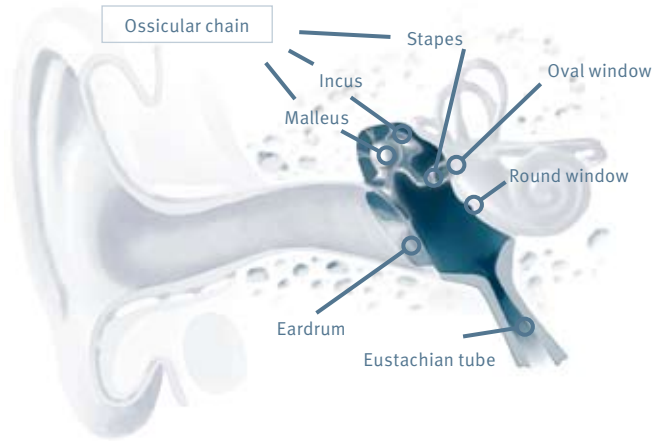

▶ Figure 2.06. The ossicles in the middle ear transfer the movements of the eardrum to the fluid-filled cavities of the inner ear.

The ossicles in the middle ear consist of three small bones which transfer sound waves from the outer ear to the inner ear.

Stapedial reflex

Two small muscles – the stapedius muscle (*musculus stapedius*) and the tensor tympani muscle (*musculus tensor tympani*) – are attached to the ossicles. These two muscles contract in a reflex response to very loud sounds.

The reflex is evoked from nerves in the brainstem telling the middle ear muscles to contract. The action of the muscles limits the motion of the ossicular chain so that the transmission of sound wave energy is slightly reduced. This may act as a protective mechanism for the inner ear to reduce damage from exposure to very loud sounds.

As the stapedius muscle dominates the response to very loud sounds, this reflex is often referred to as the stapedial reflex.

INNER EAR

Like the middle ear, the inner ear is located in the temporal bone. The inner ear consists of the auditory and balance organs. The balance organ comprises the vestibule and the semicircular canals. The auditory organ is shaped like a snail shell with two and a half turns and is called the cochlea (fig. 2.07).

In the cochlea, mechanical energy is transformed into neural impulses, which via the auditory nerve are sent to the brain. The fluid-filled cavities of the cochlea are connected to the fluid-filled cavities of the vestibule.

In the cochlea, mechanical energy is transformed into neural impulses, which are sent to the brain.



▶ Figure 2.07. The cochlea is shaped like a snail shell with two and a half turns. In the cochlea, the mechanical energy of the sound waves is transformed into neural impulses, which are transmitted to the brain via the auditory nerve.

Anatomy of the cochlea

The cochlea is divided into three fluid-filled passages:

- Scala vestibuli
- Scala media
- Scala tympani

The scala vestibuli is sealed by the oval window and the scala tympani opens into the round window. The scala media houses the organ of Corti.

The scala vestibuli and scala tympani both contain a watery fluid called perilymph, while the scala media contains a gel-like fluid called endolymph.

The three passages extend in parallel all the way up through the cochlea. The scala vestibuli and scala tympani lie on either side of the scala media and are connected to each other at the apical end of the cochlea by a small passage called the helicotrema. The scala media is the middle passage bordered by two soft membranes, Reissner's membrane and the basilar membrane (fig. 2.08).

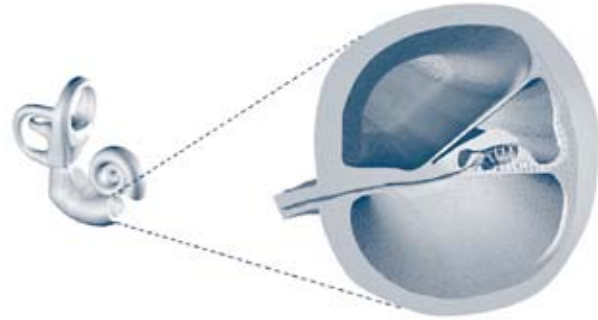

▶ Figure 2.08. A cross section of the cochlea shows three fluid-filled passages extending all the way up through the cochlea to the helicotrema.

The scala vestibuli and scala tympani terminate at the base of the cochlea in two membranes facing the middle ear (fig. 2.09):

- the oval window
- the round window

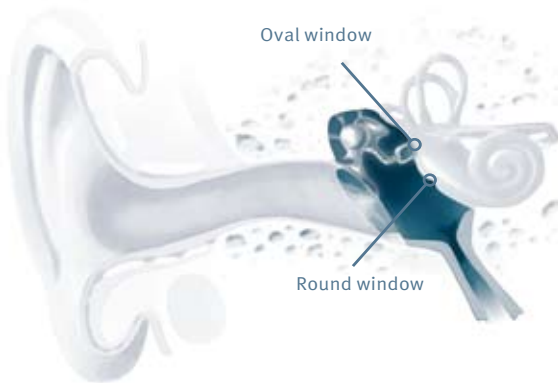

▶ Figure 2.09. Position of the oval window and the round window at the base of the cochlea.

The stapes footplate moves like a piston in and out of the oval window, producing pressure waves in the cochlea. The increased pressure in the cochlea is equalised via the round window, as its membrane moves in and out concurrently with the stapes footplate (fig. 2.10).



▶ Figure 2.10. During the transfer of mechanical energy from the sound waves to the cochlea, the stapes footplate moves in (1) and out (2) of the oval window like a piston, producing pressure waves in the fluid-filled cavities of the cochlea. The increased pressure in the cochlea is equalised via the round window, as its membrane moves in and out in tandem with the stapes footplate.

Organ of Corti, hair cells and stria vascularis

The scala media contains several structures that work together to transform energy from sound waves into neural impulses in the auditory nerve.

The organ of Corti is located on the basilar membrane. It contains the hair cells, which are located along the basilar membrane. The hair cells play a major role in generating neural impulses. Above the hair cells there is a gelatinous structure: the tectorial membrane (fig. 2.11).

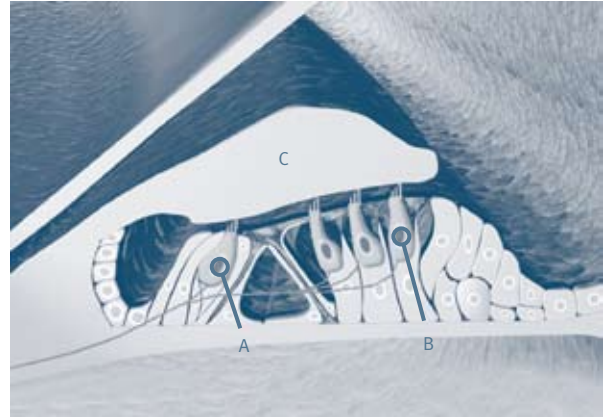

► Figure 2.11. A cross section of the cochlea with the organ of Corti, the outer (B) and inner hair cells (A) and the tectorial membrane (C).

There are two types of hair cells in the organ of Corti: the inner hair cells and the outer hair cells (fig. 2.12).

HAIR CELL TYPE	NUMBER OF CELLS	DESCRIPTION
Inner hair cells, also named sensory cells	Approx. 3,500	The inner hair cells are primarily innervated by afferent fibres, which carry impulses to the brain. The cells are arranged in a single row on the organ of Corti.
Outer hair cells	Approx. 13,000	The outer hair cells are arranged in three rows on the basilar membrane. They are innervated mostly by efferent fibres, i.e. they receive impulses from higher up in the brain.

On top of the hair cells there are small hair-like fibres, which are called stereocilia. The stereocilia of the outer hair cells are embedded in the tectorial membrane.

On the outer surface of the scala media there is a group of cells referred to as the stria vascularis. These cells produce the endolymph present in the scala media and help to maintain positive electrical potential relative to the perilymph flowing in the scala vestibuli and scala tympani. Together, the two fluids constitute a battery which supplies the hair cells with the energy required to generate neural impulses.



▶ Figure 2.12. The rows of hair cells on the basilar membrane, seen from above; at the front, the outer hair cells arranged in triangular groups, and behind, the row of inner hair cells.

Travelling wave on the basilar membrane

When the movement of the stapes propagates to the cochlea, the basilar membrane is also set into motion. The wavelike motion of the basilar membrane is also called a travelling wave, because it moves from the oval window to the helicotrema at the apex of the cochlea.

At some point on the basilar membrane, the travelling wave reaches a point of maximum displacement. The location of this displacement depends on the frequency of the sound. The basilar membrane is narrow and rigid at the base of the cochlear duct, becoming wider and less stiff towards the apex of the cochlea.

Due to these physical properties, the maximum displacement for a high-frequency sound – for example a 10 kHz tone – occurs at the base of the basilar membrane, near the oval window. For a low-frequency sound – for example 100 Hz – the maximum displacement occurs towards the apex of the cochlea, where the basilar membrane is less stiff. The maximum displacement for a sound in the mid frequencies, i.e. around 1 kHz, occurs near the middle of the basilar membrane (fig. 2.13).

For a high-frequency sound, the maximum displacement occurs at the base of the basilar membrane, near the oval window. For a low-frequency sound, the maximum displacement occurs towards the apex of the cochlea.

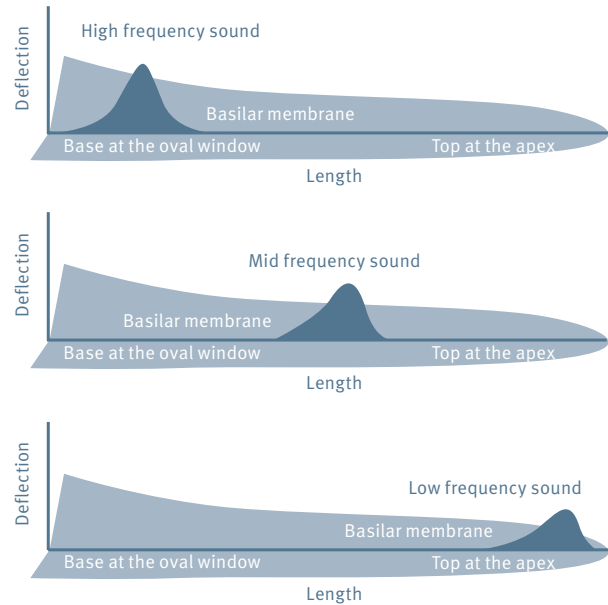

► Figure 2.13. Displacement of the basilar membrane induced by low, mid and high frequency sounds. Note that the basilar membrane is uncurled to better illustrate its shape and distribution of frequencies along the membrane.

This passive mechanism allows information about the frequency of a sound to be detected by specific groups of hair cells on the basilar membrane. This frequency information is then transmitted by the hair cells to the auditory nerve and further to the part of the brain processing auditory information.

Function of the inner and outer hair cells

Both the outer and inner hair cells are important for the transformation of fluid vibrations into neural impulses. Some theories claim that the outer hair cells act like a servo mechanism in a car, in the sense that slight vibrations of weak sounds are mechanically amplified.

The outer hair cells contain muscle-like components (microfilaments), which enable them to change shape. The hair cell movement increases the displacement of the basilar membrane, corresponding to an amplification of the sound of up to 40 dB. This happens at the point on the basilar membrane where the maximum travelling wave displacement occurs.

The outer hair cells have a significant effect at low sound levels because they increase the displacement of the basilar membrane to such an extent that the inner sensory hair cells are stimulated. The outer hair cells' effect decreases with increasing sound levels and is practically zero at high levels, as the inner hair cells are then stimulated directly by the displacement of the basilar membrane.

The inner hair cells are those that really convert the sound into neural impulses in response to displacement of the basilar membrane. The cells are primarily innervated by afferent nerve fibres, which carry impulses to the brain. The hair cell stimulation results in the release of a transmitter substance at the bottom of the cell, starting an impulse in the neural pathway.

Transmission of information to the auditory nerve

It is currently believed that information about the frequency composition of sound is transmitted through the neural pathway in two ways: one theory says that nerve fibres send impulses in phase with the incoming acoustic signal (called phase locking). Furthermore it is believed that the nerve fibres also respond according to the location on the basilar membrane where the stimulus is perceived (called the place theory).

The fact that the nerve fibres generally maintain their position in relation to each other in the auditory nerve and up through the brainstem supports the latter theory. This is referred to as the tonotopic organisation of the auditory nerve.

It is believed that information about sound level is transmitted in the auditory nerve by an increase in the impulse firing rate of individual nerve fibres. The auditory nerve houses three types of nerve fibres that respond to low, medium and high sound levels, thus enabling the auditory nerve to map the relatively large dynamic range of the human ear.

Central auditory nervous system

The afferent nerve fibres exit the organ of Corti and are gathered in the auditory nerve. The auditory nerve is the starting point of the auditory pathway, which goes from the cochlea and up through the brainstem to the auditory cortex. On its way, it passes several nuclei, each serving as a kind of relay station where the signal is processed in different ways (fig. 2.14).

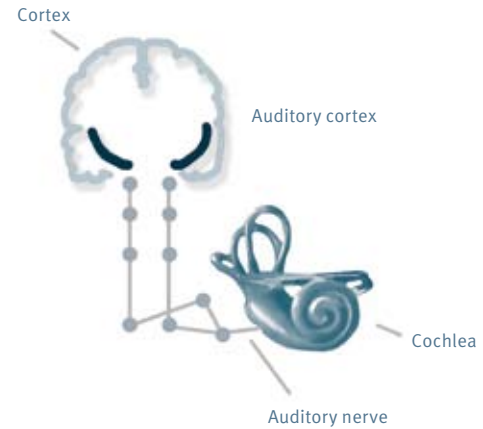

► Figure 2.14. The auditory pathway runs from the cochlea and up through the brainstem. At the cochlear nucleus, more than half of the nerve fibres cross over to the opposite side of the brainstem.

The auditory pathway splits up at the cochlear nucleus and more than half of the nerve fibres cross over to the opposite side of the brainstem. These nerve fibres are gathered in the superior olivary complex, which is a complex of nuclei involved in the localisation of sound.

From the superior olivary complex, the auditory pathway continues up through the lateral lemniscus and inferior colliculus and terminates in the auditory cortex. Here the sound information combines with visual information and information from other parts of the brain.

Also the efferent nerve fibres run through the brainstem, but in the opposite direction of the afferent nerve fibres. From the superior olivary complex, the efferent fibres run through the olivocochlear bundle and further on to the cochlea, where most of the nerve fibres adhere to the outer hair cells.

The function of the olivocochlear bundle is not fully known, but theories claim that the efferent nerve fibres might control the active mechanism of the outer hair cells.

PSYCHOACOUSTICS

The concept of psychoacoustics relates to that part of psychophysics that deals with the subjective perception of sound. The knowledge of sound perception is obtained by systematically presenting different sound signals to a group of test subjects and measuring their reactions to these.

Measuring the hearing threshold

A very common psychoacoustic measurement is the hearing threshold measurement. The hearing threshold can be established in several ways. In the following section, we describe one of the most commonly used measuring techniques – the ascending method.

Establishing hearing thresholds by the ascending method

First, a pure tone at a given frequency is presented to the test person. The tone should be audible to the test person. The level is then reduced in 10 dB steps, and the test person is asked to give a sign each time the tone is heard.

At some point, the tone becomes so soft that it is no longer audible to the test person. When this happens, the signal level is increased in 5 dB steps, until the test person can hear the tone again. Then, the level of the tone is lowered by 10 dB and a new ascending process starts. This procedure is repeated until the lowest level at which the subject is able to hear the tone at the specific frequency has been verified two or three times (fig. 2.15).

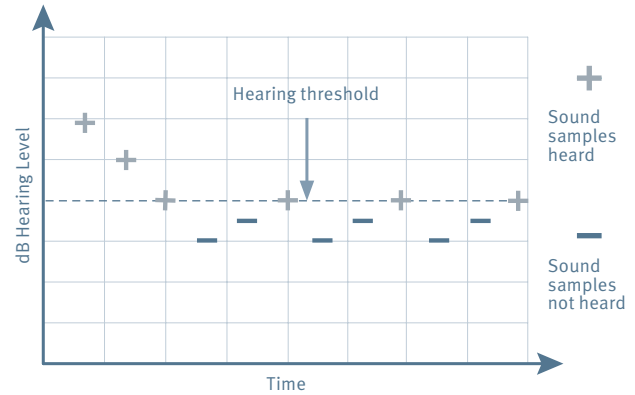

▶ Figure 2.15. The ascending method for establishing hearing thresholds. The lowest sound level at which the tone is audible to the test person is verified two or three times.

Audible range

There are a variety of sounds in our environment, ranging from weak sounds, such as birdsong and rustling leaves, to loud sounds, such as loud music, yelling and industrial noise. The entire range of sound levels that are audible to human beings is called the audible range.

The lower curve on figure 2.16 shows the average hearing threshold of a group of people with normal hearing. The measurements are made in a free field where the subjects listen binaurally (with both ears) to the test signals from a loudspeaker.

As illustrated, the softest sound that can be perceived by a person depends on the frequency of the sound. The audible frequency range is between around 20 Hz to 20,000 Hz, but hearing is most sensitive in the frequency range from 2,000 to 5,000 Hz. At lower and higher frequencies hearing sensitivity is reduced and the test tones must consequently be at higher levels for the human ear to hear them.

Figure 2.16 also shows the range for speech and music. The threshold of discomfort is shown at the top of the figure. The threshold of discomfort is established by asking the test person to indicate when the sound is uncomfortably loud.

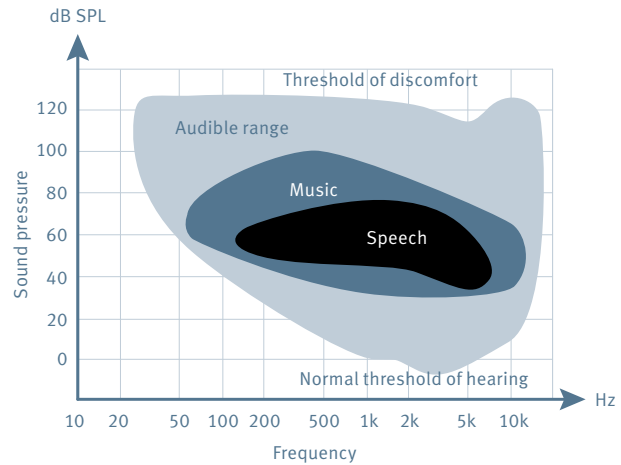

► Figure 2.16. The audible range for normal hearing including the approximate range for speech and music.

Perception of loudness

The human ear is able to perceive sound level differences as small as 1 dB. Between the curves of hearing threshold and uncomfortable loudness there is a dynamic range of approximately 120 dB, where everyday sounds are distributed. The sound level is, however, not directly an expression of the loudness perceived by the listener. In other words, there is not a one-to-one relation between sound level and perceived loudness.

Figure 2.17 shows the average loudness perception in a group of people with normal hearing. The curves are called phon curves. The phon curves are found by presenting a 1 kHz tone of a specific loudness and then another pure tone at another frequency. Then the test person is asked to adjust the volume of the other tone until it is perceived to be as loud as the 1 kHz tone.

The human ear perceives loudness in a way which is not directly related to the actual sound pressure level. The phon curves show how loud various pure tones should be to be perceived as equally loud across the frequency range.

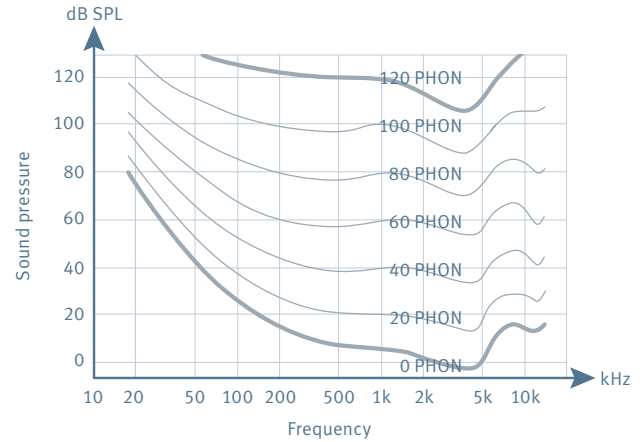

▶ Figure 2.17. Phon curves showing how loud the sound should be at the various frequencies to be perceived to be as loud as a 1 kHz tone at 20, 40, 60 etc. dB SPL. These curves are also referred to as equal loudness contours.

The phon curves thus express at which sound pressure levels the presented pure tones are perceived to be equally loud across the entire frequency range.

As illustrated in Figure 2.17, the shape of the phon curves changes depending on the sound pressure level. At low levels, they follow the curved shape of the hearing threshold, but at high levels the curves tend to become flatter.

Frequency and temporal discrimination

The human ear is able to perceive changes in the frequency of a tone, as small as a few Hertz. A person with normal hearing is also able to detect two sequential sounds with a time interval between them as small as 1-2 msec.

The ability to discriminate between these sound characteristics is believed to be highly important for our ability to hear and understand speech.

Masking

When listening to a soft and a loud sound simultaneously, it is often difficult to hear the soft sound as it is drowned by the loud sound. This phenomenon is called masking. The masking effect is largest when the soft sound is in the same frequency range as the loud sound.

The phenomenon that a loud sound drowns a softer sound is called masking.

Even when the soft sound is not in the same frequency range as the loud sound, masking can occur. This is sometimes called remote masking. Remote masking is most pronounced when the loud sound is a lower frequency sound than the soft sound, rather than the opposite. The reason for this is that low-frequency sounds set a large part of the basilar membrane in the cochlea into motion and thus “drown” the smaller waves occurring at higher frequencies. When low-frequency sounds mask high-frequency sounds, we speak of the upward spread of masking (fig. 2.18).

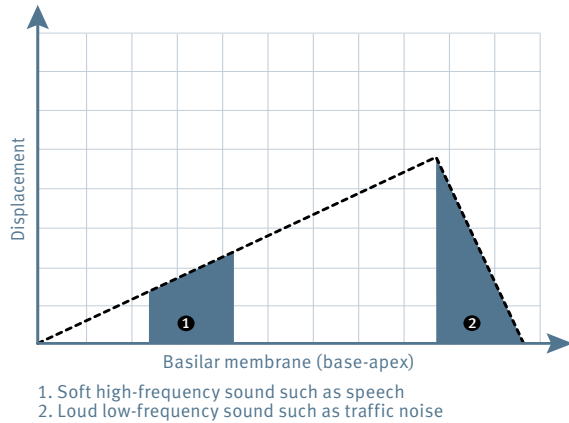

► Figure 2.18. The maximum displacement for a low-frequency sound occurs at the apex of the basilar membrane. At the same time, a large part of the membrane is set into motion, causing smaller high-frequency waves to be “drowned”. This is called the upward spread of masking.

Masking can also occur when two sounds are not presented at the same time, but are spaced in time. When, for example, a loud sound is followed by a soft sound after a brief interval, the soft sound will be masked. This is called forward masking. Forward masking does not occur when the time interval between the two sounds is more than 200 milliseconds (fig. 2.19).

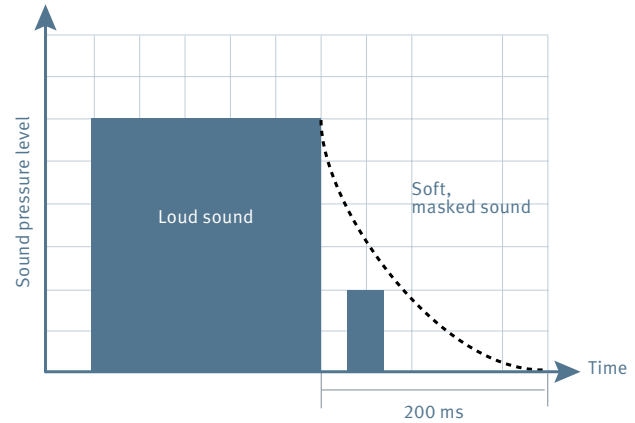

► Figure 2.19. Forward masking occurs when a loud sound is followed by a soft sound after a brief interval. The soft sound cannot be detected by the listener because it is masked by the louder sound which was presented immediately before.

Masking is a very common experience, for example when communicating in traffic noise. This is usually not a problem for people with normal hearing, because the speech signal contains so much extra information that they can still understand what is being said. To a person with hearing loss, however, background noise can make it almost impossible to understand conversation, because a large part of the audible speech signal is lost.

A series of thin, light gray wavy lines that flow across the page from left to right, creating a sense of movement and depth. The lines are layered, with some appearing in front of others, and they all converge towards the right edge of the page.

[CHAPTER 3]
TYPES AND CAUSES OF HEARING LOSS



CHAPTER 3

TYPES AND CAUSES OF HEARING LOSS 61

CONDUCTIVE HEARING LOSS 62

Accumulation of ear wax 63

Otitis media 64

Cholesteatoma 65

Otosclerosis 65

SENSORINEURAL HEARING LOSS 66

Age-related hearing loss 68

Noise-induced hearing loss 69

Acoustic trauma 69

Accumulated acoustic trauma 69

Prevention of noise damage 70

Hereditary hearing loss 70

Congenital and birth-related hearing loss 71

Hereditary predispositions 71

Infections during pregnancy 71

Complications during birth 71

Perinatal infections during the first week after birth 72

Diagnosis of infant hearing loss 72

Retro-cochlear disorders 72

FURTHER HEARING DISORDERS 73

Tinnitus 73

Ménière's disease 74

Ototoxicity 75

Auditory processing disorders 75

TYPES AND CAUSES OF HEARING LOSS

The range of audibility of an individual with a hearing loss is smaller than that of someone with normal hearing. Depending on the degree of hearing loss, parts of the speech signal may no longer be audible, and speech intelligibility may be reduced. This is likely to be experienced as a hearing problem. A hearing loss can occur suddenly or develop gradually over a period of time. Hearing loss may result from disorders anywhere in the hearing system and may affect the perception of different frequency ranges (fig. 3.01).

There are two major types of hearing loss depending on the location of the disorder in the ear:

- Conductive hearing loss
- Sensorineural hearing loss

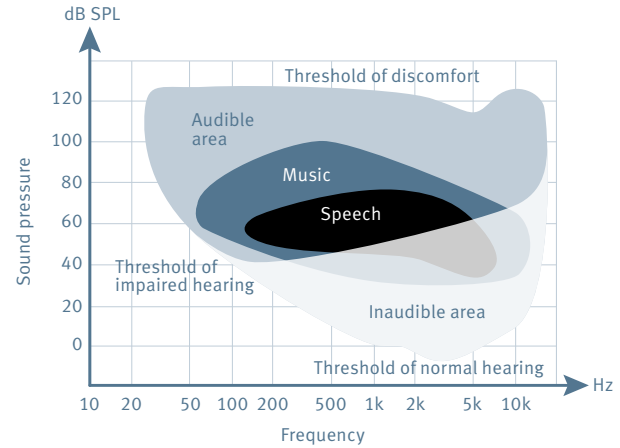

▶ Figure 3.01. Example of the audible range of a person with a high-frequency hearing loss of 40 to 60 dB compared to that for normal hearing. The figure shows that parts of speech and music are inaudible to this person.

CONDUCTIVE HEARING LOSS

Conductive hearing loss occurs when the passage of sound is blocked, either in the ear canal or in the middle ear. If this happens, the sound level is reduced on its way to the cochlea in the inner ear (fig. 3.02).



▶ Figure 3.02. Conductive hearing loss may originate in the outer or middle ear.

Conductive hearing loss is characterised by inefficient transmission of sound, either in the ear canal or in the middle ear.

Some types of conductive hearing loss can be treated medically or surgically. Other types of conductive hearing loss can be effectively corrected with hearing aids because the organ of Corti in the cochlea functions normally, and it is therefore mainly a question of overcoming the transmission barrier in the outer or middle ear.

In the following sections, some causes of conductive hearing loss are described:

- Accumulation of ear wax
- Otitis media
- Cholesteatoma
- Otosclerosis

Accumulation of ear wax

The glands in the ear canal continuously produce ear wax (cerumen). Sometimes ear wax accumulates in the ear canal and may even block it totally. This is often seen when a hearing aid is used, since the earmould or shell tends to compress the wax in the ear canal, leading to the formation of plugs. Ear wax plugs may attenuate sound substantially and be of great annoyance (fig. 3.03).

Plugs of ear wax can usually be removed with an ear wax solvent. Plugs that cannot be removed in this way should only be removed by a skilled person, such as an ENT doctor or a medically trained professional. An attempt by an unskilled person to remove the plug with, for example, a cotton bud may result in irritation to the ear canal, cause the ear wax to be pushed together into an ear wax lump or damage the eardrum.



▶ Figure 3.03. An ear wax plug blocking the ear canal.

Otitis media

Inflammation of the middle ear (otitis media) is a very common problem, especially in children. Otitis media can be acute or chronic. Acute otitis media usually results from an infection at the back of the throat where bacteria spread to the middle ear via the eustachian tube. Here, infectious fluid is produced, causing earache and a transient conductive hearing loss. An acute otitis media must be assessed immediately by an ENT doctor. The treatment may be in the form of antibiotics or a small incision in the eardrum to drain the ear of fluid.

Chronic otitis media is a long-standing infection of the middle ear. It is caused by a permanent hole in the eardrum or a cholesteatoma. This hole in the eardrum might be present without producing any symptoms, but sometimes a chronic bacterial infection develops. Chronic otitis media is usually painless and may be accompanied by unpleasant odour from the ear.

In some cases fluid may leak into the ear canal. Much care should be taken when fitting hearing aids to persons with chronic otitis media, because the presence of an earmould in the ear canal can increase the likelihood of repeated infections. Chronic otitis media is usually managed by an ENT doctor.

Serous otitis media is an accumulation of fluid in the middle ear, and therefore it is often called otitis media with effusion. It can develop from acute otitis media that has not completely cleared, or from eustachian tube dysfunction. The dysfunctional eustachian tube does not permit sufficient ventilation of the middle ear, whereby pressure in the middle ear tends to decrease. This leads to accumulation of fluid in the middle ear and transient conductive hearing loss. Serous otitis media is particularly common in childhood, while the eustachian tube is immature. It can last for weeks or months at a time, and because it is not usually painful, children will not complain of ear problems. As the child's language development may suffer due to the related hearing loss, the disease must be diagnosed and treated as early as possible. Serous otitis media is treated medically or surgically. Surgery usually involves the insertion of a small ventilation tube – a grommet – into the eardrum, in order to re-establish and maintain a normal pressure in the middle ear.

Cholesteatoma

Secondary to chronic or other kinds of otitis media, a cholesteatoma may develop. A cholesteatoma is a tumour-like mass of cells and cholesterol that erodes the bones of the middle ear, resulting in conductive hearing loss.

A cholesteatoma may also develop in the moist ear canal, where it may erode the inner bony part of the ear canal and thereby form a major cavity near the eardrum.

Cholesteatomas should be treated surgically. In a progressed stage, the ossicles in the middle ear may be affected, but a corrective operation is in some cases possible.

Otosclerosis

Otosclerosis is a middle ear disease. It is characterised by excessive bone growth in the middle ear. Otosclerosis may cause the stapes footplate to become gradually fixed within the oval window, resulting in conductive hearing loss, which is initially most pronounced at the low frequencies. If bone growth spreads into the cochlea, the hearing loss can have a sensorineural component (fig. 3.04).

It is often possible to improve the hearing ability in a person with otosclerosis by surgery. The ossified stapes is replaced by a prosthesis to allow the ossicles to function again. If surgery is not or cannot be performed, the hearing loss can often be effectively corrected with a hearing aid.

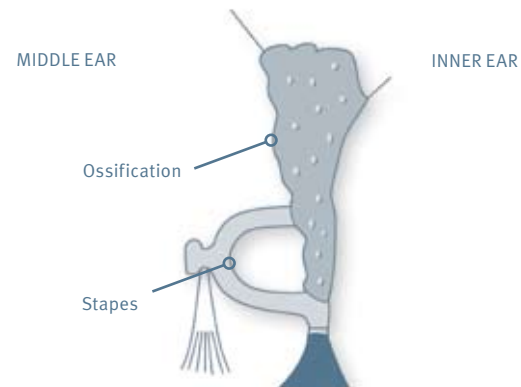

▶ Figure 3.04. Otosclerosis is a disorder of bone growth around the stapes (ossification), causing the ossicles to become gradually fixed and hindering the conduction of sound waves from the eardrum to the inner ear.

SENSORINEURAL HEARING LOSS

Sensorineural hearing loss is due to a disorder in the cochlea or in the auditory nerve (fig. 3.05).



▶ Figure 3.05. The cochlea and the auditory nerve in the ear where sensorineural hearing loss occurs.

The origin of sensorineural hearing loss is in the cochlea or the auditory nerve.

A very common cause of sensorineural hearing loss is damage to the hair cells on the basilar membrane. The outer hair cells are generally likely to be damaged first, resulting in reduced sensitivity to soft sounds.

The perception of loudness is also affected. In the frequency range where hearing sensitivity is reduced, the audible range is restricted and loudness perception compressed. As a result, a hearing impaired person may perceive the sound of, for example, 50 dB SPL as soft, whereas a person with normal hearing may perceive the same sound as comfortable. A sound of, for example, 100 dB SPL is perceived as very loud by both. This is called loudness recruitment (fig. 3.06).

However, recent research suggests that sounds presented at a level just above the elevated hearing threshold are perceived to be relatively loud by the hearing impaired. In other words, the ear has lost its ability to perceive a sound as very soft. This is called softness imperception.

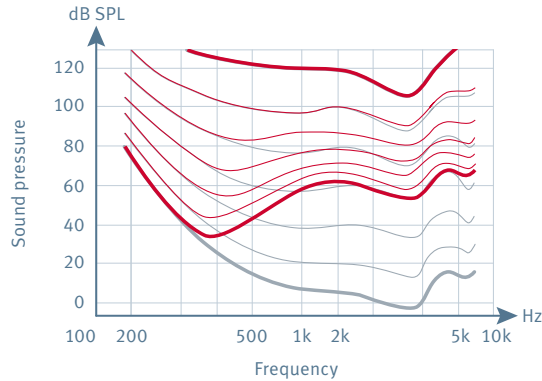

► Figure 3.06. Comparison of the phon curves for normal hearing and high-frequency hearing loss of about 50 dB (red curves). In the frequency range with reduced hearing sensitivity, the audible range is restricted and loudness perception compressed.

If the hair cells are damaged, the frequency resolution of the ear is reduced because the auditory filters in the cochlea become wider and less defined. As a result, the ability to distinguish different speech sounds can suffer.

It is generally not possible to correct sensorineural hearing loss surgically or medically. A commonly chosen alternative is the use of hearing aids. Sensorineural hearing loss can occur at any time in life and for a variety of reasons. The types below are described in the following sections:

- Age-related hearing loss
- Noise-induced hearing loss
- Hereditary hearing loss
- Congenital and birth-related hearing loss
- Retro-cochlear disorders

Age-related hearing loss

Age-related hearing loss is also known as presbycusis. It is a very common type of sensorineural hearing loss. Presbycusis occurs due to age-related changes in the cochlea and auditory pathways.

Typically, presbycusis starts to develop at the age of about 60 years and onwards. The hearing loss develops symmetrically in both ears and first affects the hearing sensitivity at high frequencies. If an individual has acquired a hearing loss earlier in life, for example, due to noise in the working environment, this hearing loss will, so to speak, be an additional component to the naturally occurring age-related hearing loss.

Presbycusis occurs as a result of the ordinary ageing process; it is characterised by a progressive hearing loss starting at the high frequencies.

Besides the hearing loss itself, the ability to distinguish different speech sounds can be reduced. At higher levels in the brain, the ageing process may affect the recognition process used to link up different sounds.

Hearing loss may lead to isolation and reduced quality of life. Depending on the magnitude of the communication problems associated with the age-related hearing loss, it is often a good idea to suggest the use of hearing aids.

Early treatment with hearing aids is recommended because it often becomes physically and psychologically more difficult with age to get used to wearing hearing aids. Another success factor is that the hearing impaired person acknowledges the hearing loss and the need to use hearing aids, before the fitting process is initiated.

Noise-induced hearing loss



In today's world, we are constantly exposed to sounds, both at work and outside work. Many of these sounds can be considered as noise, which is often annoying and tiring. Excessive noise exposure may cause hearing loss.

Acoustic trauma

Acoustic trauma can occur suddenly as a result of exposure to a transient, high-intensity sound. This impulse noise could be produced by, for example, fireworks or firearms, which may also create a shock wave of short duration.

The shock wave affects the hair cells in the cochlea and results in an acute hearing loss, often accompanied by dizziness and sounds in the ears. The hearing loss is usually only temporary and improves within a few days after the noise exposure. However, normal hearing may not always be completely restored.

Accumulated acoustic trauma

Acoustic trauma can also occur after long-term exposure to noise, for example when working in a noisy environment or for professional musicians.

Due to this noise exposure the hearing sensitivity can be reduced temporarily. This phenomenon is called Temporary Threshold Shift and is abbreviated TTS. If the TTS is repeated a number of times, the threshold shift may become a permanent one (Permanent Threshold Shift, PTS). Then the hair cells in the inner ear have been damaged beyond their natural recovery capabilities.

Prevention of noise damage

People who work in environments with high-level noise must protect their hearing. If the noise source cannot be reduced or shielded, it is recommended to use hearing protection to avoid noise-induced hearing loss. There is a wide selection of hearing protection available for this purpose, such as foam plastic plugs and ear muffs.

Hereditary hearing loss

Hereditary hearing loss may already exist from the time of birth or develop later in life. A hereditary hearing loss will often be progressive, demanding increasing levels of amplification from hearing aids.

One of the characteristics of hereditary hearing loss is the shape of the curve showing a person's hearing thresholds at various frequencies in the audible range (i.e. the audiogram). Hereditary hearing loss does not show any specific relationship between frequencies and hearing thresholds. For example, one type gives a low-frequency hearing loss, whereas another type results in loss of sensitivity in the mid-frequency region.

In recent years, great progress has been made in the identification of the genes that cause hereditary hearing impairment. Nearly all types of hearing loss have been found to have a hereditary component. Therefore, a person may be predisposed for developing, for example, age-related hearing loss.

Congenital and birth-related hearing loss

In some cases, hearing impairment exists from the time of birth. Such hearing loss is called congenital and can be conductive and/or sensorineural. It may be due to special circumstances during pregnancy or at birth. Approximately two to six children out of one thousand are born with a hearing loss that requires treatment.

Hereditary predispositions

Hereditary hearing loss is caused by genetic factors. The hearing loss can be present at birth, or the onset may be any time during childhood or adult life. Hereditary hearing loss is not necessarily present in one of the parents. Hereditary hearing loss can be part of another disease, which may involve deformity of other parts of the body and affect the other senses and body functions.

Infections during pregnancy

Another cause of congenital hearing loss is infection during pregnancy. Previously, rubella (German measles) was a common cause of congenital hearing impairment. In countries where vaccination against this and other viral diseases has been introduced, the frequency of this type of hearing loss has fallen drastically. Other common types of infectious agents include toxoplasmosis, cytomegalovirus, herpes simplex and syphilis.

Complications during birth

The hearing impairment can also be associated with complications during childbirth, like blood poisoning, or for example in connection with low birth weight and lack of oxygen. Jaundice, which is common in newborn babies, can in severe cases be associated with hearing loss.

CAUSES OF CONGENITAL AND AFTER-BIRTH HEARING LOSS		
DURING PREGNANCY	DURING BIRTH	AFTER BIRTH (PERI- AND NEONATAL)
<ul style="list-style-type: none"> • Genetic factors • Deformity • Infections in the mother 	<ul style="list-style-type: none"> • Premature birth, low birth weight • Oxygen deprivation • Jaundice 	<ul style="list-style-type: none"> • Ototoxicity • Meningitis • Otitis media (some months old)

Perinatal infections during the first week after birth

Newborn babies, especially premature babies, are susceptible to infections like, for example, pneumonia. Another serious infection, which often results in sensorineural hearing loss in newborn babies, is meningitis.

Diagnosis of infant hearing loss

About half of the infants born with hearing loss belong to special risk groups. These risk groups are often under observation for other complications or anomalies. To ensure that the hearing of these risk group babies is checked, their hearing should be evaluated as part of the general diagnostic process to allow early treatment with hearing aids, if a hearing loss is diagnosed.

In the other half of infants born with hearing loss, there is no known indicator for this loss. Unless screening of newborn babies' hearing is part of their routine examination, it may take years before any hearing loss is diagnosed.

Studies have shown that early diagnosis and hearing aid treatment are very important for the child's language development. It is important for a child to receive auditory stimulation during the first six critical months of speech and language development, at which time important development occurs at the brain level. A delay in speech and language may therefore develop if a hearing loss is not treated during this period.

Retro-cochlear disorders

A special category of sensorineural hearing loss is called retro-cochlear, because it is caused by damage to nerve pathways between the cochlea and part of the brain responsible for hearing. Multiple sclerosis is an example of a retro-cochlear disorder.

In rare cases, the damage can be due to a tumour on the auditory nerve, also called an acoustic neuroma. This kind of tumour is benign and grows very slowly.

The initial symptoms from the pressure of the tumour on the auditory nerve may be a mild hearing loss, reduced speech discrimination ability and tinnitus.

Another symptom may be dizziness caused by the fact that the nerve fibres from the balance organ also run together with the auditory nerve. If the tumour starts to place pressure on the facial nerve, which runs parallel to the auditory nerve, facial paralysis may occur.

The tumour may become life-threatening when it becomes excessively large and begins to apply pressure on the brain. Removal of the tumour by surgery may involve a risk of the patient losing his or her hearing ability on the affected side, accompanied by a facial palsy.

FURTHER HEARING DISORDERS

In the following sections further hearing disorders are described:

- Tinnitus
- Ménière's disease
- Ototoxicity
- Auditory processing disorder

Tinnitus

Tinnitus, also called ringing in the ears, can be described as a sensation of ringing or other sounds in the ears. The tinnitus sound is absent externally and can only be perceived by the affected person. The cause of tinnitus is not fully known. Current theories claim that tinnitus is caused by the spontaneous occurrence of neural impulses in the auditory nerve. These neural impulses are registered as sound by the part of the brain processing auditory information. Tinnitus can be in the form of many different sounds including constant ringing, buzzing or clicking.

Tinnitus is not a disease, but often a symptom of damage in the cochlea or the auditory nerve. At this time, no medical or surgical treatment exists that can cure tinnitus.

It is estimated that about 10-15 % of the population has tinnitus. The majority of the affected individuals are not irritated by the sound, they can tolerate it and only notice it in quiet surroundings. To other people, however, the tinnitus sound is so disturbing that it affects their quality of life – partly because the sound is constantly noticeable, and because of psychological consequences such as difficulty in concentrating, sleeping difficulties and anxiety. In such cases, professional assistance, for example with psychological or relaxation exercises, may be required.

It is not unusual for hearing impaired people to have tinnitus. The tinnitus sound will often be in the frequency range where the person has loss of sensitivity. Many hearing aid users experience relief when wearing hearing aids, because the amplified sound masks or “drowns” the tinnitus sound, allowing the person to focus on other sounds in the environment.

Ménière's disease

Ménière's disease is characterised by episodic vertigo, coinciding with hearing loss and tinnitus. The disease was first described in 1861 by the French doctor Prosper Ménière, who himself suffered from the disease. An attack of Ménière's is often accompanied by nausea and vomiting, and it may last from a few minutes up to several hours. The attacks may be frequent, for example, several times a week, or several months may pass between the attacks.

The vertigo associated with Ménière's disease is a form of dizziness which gives a sensation of spinning or whirling. The attack is accompanied by hearing loss on the affected ear, usually at low frequencies. In between the attacks, the ability to hear may be normalised. But after repeated attacks the hearing loss becomes increasingly permanent and the auditory discrimination ability deteriorates.

Research in the cause and possible treatment of Ménière's disease has been intensified in recent years. One of the accepted theories claim that Ménière's attacks are caused by accumulation of fluid in the cochlea and balance organ.

The symptoms of Ménière's disease can be treated with different types of drugs, which may reduce the intensity and frequency of attacks. In some cases, the accumulation of fluid in the inner ear can be improved by treatment.

Due to the fluctuating hearing loss and the distorted perception of sound, it is a difficult process to fit a person suffering from Ménière's disease with hearing aids. It is an advantage if the hearing aid is provided with a volume control, allowing the user to adjust the volume according to their changing hearing ability.

Ototoxicity

Certain types of drugs are harmful to the hearing function, including some of the drugs used for treating cancer, certain types of aminoglycoside antibiotics or drugs to cure malaria. The drugs have a toxic effect on the hair cells in the cochlea and can cause sensorineural hearing loss. The hearing loss is often bilateral and starts at the high frequencies.

The degree of toxicity depends on a number of factors, such as the drug dosage, the patient's age and health, kidney function etc.

During the treatment phase, when there is a risk of developing ototoxic hearing loss, the patient's hearing function will often be tested at regular intervals. If there are initial signs of ototoxic hearing loss, an alternative drug type may be prescribed which does not affect hearing as a side effect.

Some chemical agents used in industry may also result in ototoxic hearing loss, for example organic solvents and some types of heavy metals. These substances may attack the central nervous system and thus the part of the brain processing auditory information. In many cases, such a hearing loss will also result in reduced auditory discrimination ability.

Auditory processing disorders

This disorder is due to reduced ability to process sound signals higher up in the central auditory system – that is in the brainstem and in the brain itself. It is called a Central Auditory Processing Disorder, abbreviated CAPD.

The hearing sensitivity of those with auditory processing disorder is usually normal, but they still have difficulty perceiving sound, understanding speech and handling difficult listening situations, such as in background noise. Other manifestations may include difficulties with coordinating sound signals from the two ears, which is important for locating a sound source. When a child has auditory processing disorder, it may affect the child's language development and well-being at home and in school. Auditory processing disorder may be caused by a variety of anatomical and/or physiological phenomena from various locations in the auditory system. It is important that an accurate diagnosis is made for these children, in order to create the best listening conditions and exclude other possible difficulties as early as possible.

A series of thin, light gray wavy lines that flow across the page from left to right, creating a sense of movement and depth. The lines are layered, with some appearing in front of others, and they all converge towards the right edge of the page.

[CHAPTER 4]
AUDIOMETRY



CHAPTER 4

AUDIOMETRY 79

The hearing test 79

The dB HL scale and the audiogram 80

Hearing assessment in children 82

MEASURING AIR AND BONE CONDUCTION 83

Measurement of air-conduction thresholds 83

Measurement of bone-conduction thresholds 84

Localising the cause of the hearing loss 85

MASKING 87

Criteria for using masking 88

SPEECH AUDIOMETRY 88

Speech reception threshold 88

Speech recognition 89

UNCOMFORTABLE LOUDNESS AND MOST COMFORTABLE LOUDNESS 90

PHYSIOLOGICAL MEASURES 90

Acoustic immittance measures to assess middle ear function 90

Tympanometry 92

Measurement of the stapedial reflex 92

Otoacoustic emissions 94

Auditory Evoked Potentials 95

CALIBRATION OF AUDIOMETRIC EQUIPMENT 97

Calibration of earphones 97

Calibration considerations 98

AUDIOMETRY

Our hearing ability can be measured and mapped through various types of measurements. A wide variety of behavioural and physiological measures are available to assess hearing sensitivity and to determine the degree and causes of hearing losses.

In this chapter we will look at the hearing test, measurement of air-conduction and bone-conduction thresholds as well as masking used in audiometry. Other subjects described are speech audiometry, hearing assessment in children and the main physiological measurements. General information about calibration of audiometric equipment is provided at the end of the chapter.

The hearing test

The hearing test is usually performed in a sound-treated test room or booth. Sound-absorbing materials cover the walls to reduce sound reflections and standing waves.



► Figure 4.01. During the hearing test, the test person is placed in a sound-treated room or booth. The audiologist observes the client through a window and communicates with the client through an intercom system. Most hearing tests are conducted with an audiometer.

Most hearing tests involve the use of an audiometer. The audiometer is calibrated to emit test signals of different sound pressure levels and frequencies. The test person is asked to indicate when the test signal is audible, for example by pushing a button or by repeating the words presented (fig. 4.01).

The dB HL scale and the audiogram

As described in the chapter “Introduction to acoustics”, sound pressure level is expressed in decibels sound pressure level (dB SPL), where 0 dB SPL corresponds to a sound pressure of 20 μ Pa. The chapter “The auditory system” describes how the average hearing threshold for people with normal hearing can be expressed in dB SPL across the audible frequency range.

In audiometry, the dB SPL scale is not used to indicate hearing thresholds. Instead, hearing thresholds are expressed in decibels hearing level (dB HL). This scale is referenced to the normal hearing threshold curve. 0 dB HL corresponds to the average normal hearing threshold for the different audiometric test frequencies.

The dB SPL curve for normal hearing is stretched out and becomes the zero line in a new graph using the dB HL scale. Traditionally, the graph is turned upside down for audiological purposes, which means that the 0 dB HL line is at the top of the graph. The representation of dB HL values is called an audiogram (fig. 4.02).

The unit decibel hearing level (dB HL) indicates deviation in dB from the average normal hearing threshold.

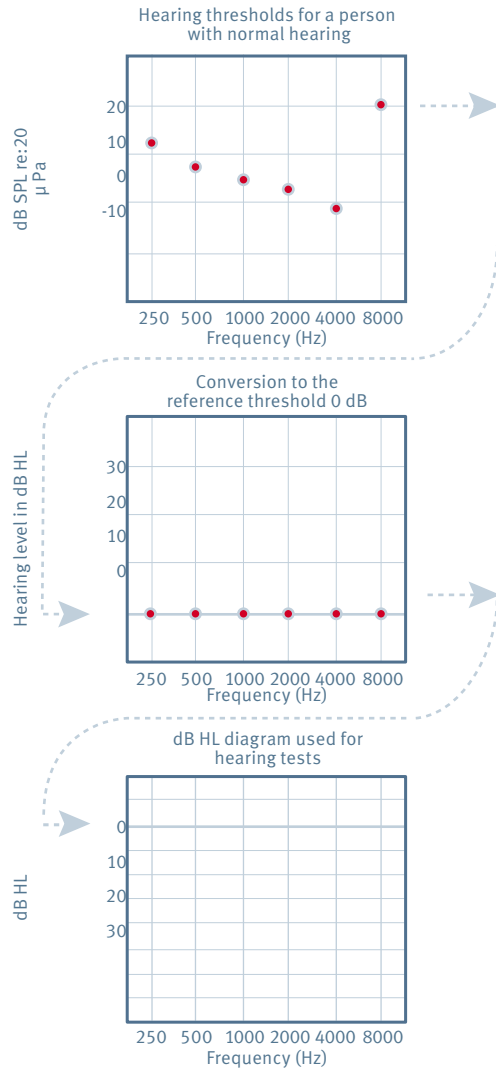

► Figure 4.02. The audiogram is based on the normal hearing thresholds. During a hearing test, the client's hearing thresholds are plotted on an audiogram. The audiogram uses a special scale, decibel hearing level (dB HL). The 0 line corresponds to the average normal hearing threshold.

The audiogram depicts the hearing thresholds of an individual relative to normal hearing. Sometimes, parts of a hearing curve are above the 0 line of the audiogram, e.g. at -5 or -10 dB HL. Negative dB HL values indicate that the test person's hearing is better than average normal hearing. However, it should be remembered that the 0 line of the audiogram represents the average normal hearing threshold, and that some people's hearing thresholds will be better than average.

A person whose threshold values are higher than 25 dB HL at one or more frequencies is defined as having a hearing loss. Hearing losses are usually classified as follows.

HEARING LOSS	DB HL
Normal	-10 to 15
Slight/minimal	16 to 25
Mild	26 to 40
Moderate	41 to 55
Moderately severe	56 to 70
Severe	71 to 90
Profound	> 91

Hearing assessment in children

Children are usually not able to participate in hearing tests conducted with a conventional audiometer until around the age of five years. For younger children, other types of tests must be chosen.

The hearing ability of a child younger than about six months of age is estimated by measuring the brain's reaction to sound by means of physiological techniques, where small electrodes are placed on the child's scalp during the test.

Around the age of six months the child gains more control of his/her motor function. Now, the hearing assessment test can be performed with the child sitting between two loudspeakers, or with headphones. When the child turns its head toward the side from which the sound is presented, they are rewarded by the activation of an illuminated and moving toy. The testing of older children requires the active participation of the child, who gets to press a button or drop a block in a bucket when the sound presented through the earphones is audible (fig. 4.03).

The use of different sound sources can give a good first impression of a child's hearing ability.



► Figure 4.03. Testing of children by means of Visual Reinforcement Audiometry, where the child turns its head toward the sound and sees the toy move.

Early identification and treatment of a hearing loss are very important for the child's language development. Research has shown that the child's language learning capacity is delayed and possibly reduced in the absence of speech stimulation before the age of around six months.

MEASURING AIR AND BONE CONDUCTION

A hearing loss can be conductive or sensorineural or a combination (mixed hearing loss). To evaluate the type of hearing loss, audiologists use the fact that sound can be transmitted to the cochlea in two ways.

- Air conduction; transmission of sound to the cochlea through the ear canal and middle ear.
- Bone conduction; transmission of sound to the cochlea by vibration of the skull.

Measurement of air-conduction thresholds

Air conduction is measured by presenting test signals to the client through supra-aural earphones. Also insert earphones can be used. Insert earphones consist of a small tube, one end of which is provided with a foam cuff which is inserted in the ear canal. The other end is connected to the sound generator. The advantages of insert earphones are that they fit tightly in the ear and that they eliminate the risk of a collapsed ear canal in response to pressure against the pinna – a phenomenon sometimes seen with supra-aural earphones (fig. 4.04).



► Figure 4.04. There are different kinds of earphones available for measurement of air-conduction thresholds: supra-aural earphones that are placed on the ears (above) or insert earphones (below) which are inserted directly into the ear canal.

Via the audiometer, a number of test tones are presented to the client, which usually include 250 Hz, 500 Hz and 1, 2, 4, and 8 kHz. The tones are presented according to the ascending method by which the signal levels are varied from inaudible to audible. The hearing thresholds are plotted on the audiogram, for example using blue crosses for the left ear and red circles for the right ear (fig. 4.05).

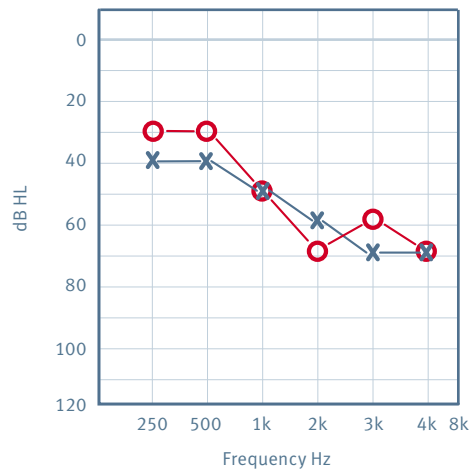

► Figure 4.05. The audiogram shows the air-conduction thresholds for a moderately severe high-frequency hearing loss (left ear = blue crosses, right ear = red circles).

Measurement of bone-conduction thresholds

For the measurement of bone-conduction thresholds, a bone-conduction vibrator is used. The vibrator is placed on the temporal bone, behind the ear or on the forehead. The vibrator transmits the test tones to the cochlea in the inner ear through vibration of the bones of the skull (fig. 4.06).



► Figure 4.06. Vibrator measurement of bone-conduction thresholds.

The bone-conduction thresholds are plotted on the audiogram with specific symbols, for example red and blue square brackets. As the vibrations produced by the vibrator propagate through the entire skull and may be heard by both ears, common bone-conduction thresholds for the two ears are often plotted on the audiogram (fig. 4.07).

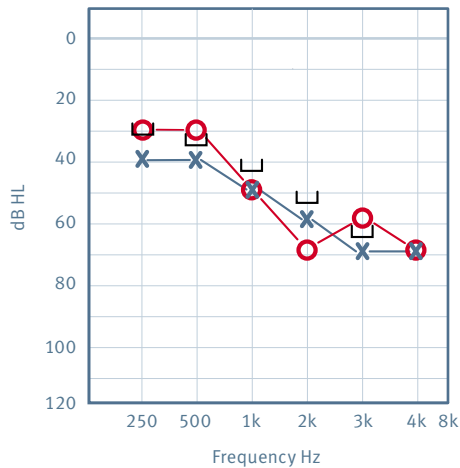

► Figure 4.07. The audiogram shows a moderately severe high-frequency hearing loss in both ears. The common bone-conduction thresholds for the two ears are indicated by means of horizontal square brackets.

Localising the cause of the hearing loss

If the air-conduction and bone-conduction thresholds are the same, the hearing loss is categorised as a sensorineural hearing loss, which means that it originates in the cochlea or its neural connections.

If the air-conduction and bone-conduction thresholds are the same, the hearing loss is categorised as a sensorineural hearing loss.

If the bone-conduction threshold lies within the normal hearing range, but the air-conduction threshold is reduced, the hearing loss is categorised as a conductive hearing loss – this hearing loss is caused by difficulty in conducting sound, either in the ear canal or middle ear. The bone-conduction threshold is also an indication of the cochlear reserve, which is the hearing ability that would be present without the conductive hearing loss (fig. 4.08).

If the bone-conduction threshold lies within the normal hearing range, but the air-conduction threshold is reduced, a conductive hearing loss is present.

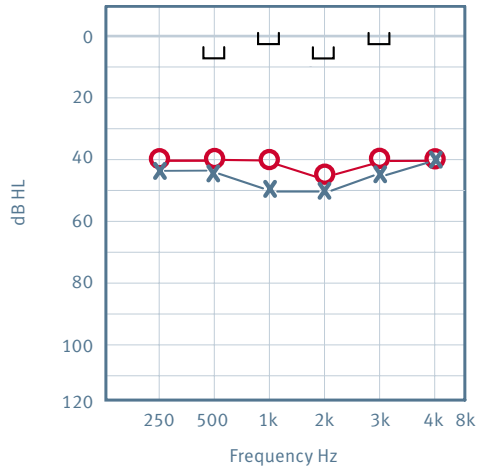

▶ Figure 4.08. Audiogram showing a conductive hearing loss. The air-conduction threshold is reduced, whereas the bone-conduction threshold is within the normal hearing range.

A mixed hearing loss is characterised by air-conduction and bone-conduction thresholds that are both reduced, but to a varying extent (fig. 4.09).

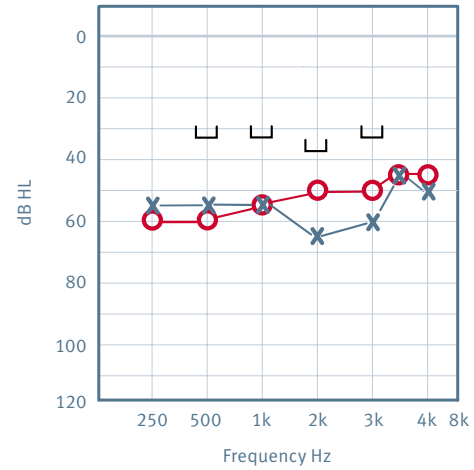

▶ Figure 4.09. Audiogram showing a mixed hearing loss. Both the air-conduction and bone-conduction thresholds are reduced, but to a varying extent. The hearing loss has a conductive as well as a sensorineural component.

Note that the bone-conduction threshold will always be at the same level or better than the air-conduction threshold.

MASKING

If the hearing ability of the left and right ear differs significantly, it may be necessary to use masking when measuring the air-conduction and bone-conduction thresholds. An example could be if a test person has normal hearing in one ear and moderate sensorineural hearing loss in the other ear.

When measuring air-conduction thresholds for the poorer ear, the better, non-test ear must be masked in order to prevent influence from the better non-test ear on the poorer ear.

Masking is used when there is a risk that the non-test ear can detect the test tones presented to the test ear.

To measure the air-conduction thresholds on the ear with poorer hearing, tones are presented to that ear. When the test tones reach a relatively loud level, they will cross over the head via vibrations of the skull and be detected by the non-test ear (cross hearing). This may cause the test person to react at a level where the sound is still too soft to be detected by the poorer, test ear, and the measurement will not reflect the real hearing ability of the test ear (fig. 4.10).

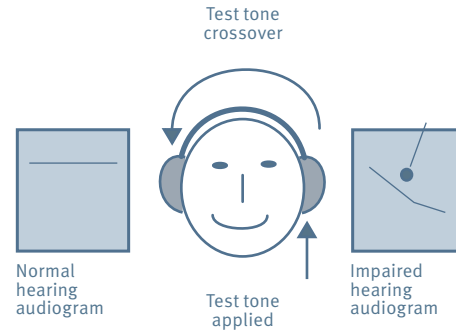

► Figure 4.10. Crossover occurs when the test tones used to measure the hearing threshold of the test ear are detected by the opposite, non-test ear. The test person therefore reacts to the test tone, although it is actually too soft to be detected by the test ear.

Crossover can be avoided by masking the non-test ear with a noise signal centred around the frequency used for the test tone. By doing so, the hearing threshold of the non-test ear is raised, allowing the correct threshold of the test ear to be determined (fig. 4.11).

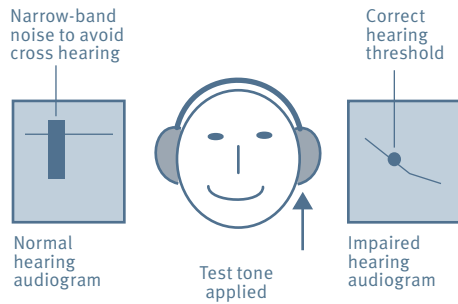

▶ Figure 4.11. Narrow-band masking is used to raise the hearing threshold of the non-test ear, thus making it possible to establish the real hearing threshold of the test ear.

Criteria for using masking

The need for masking depends on the type of earphones used in the hearing test. With supra-aural earphones, interaural attenuation across the head can vary from 35 to 50 dB, which means that the test tone presented should be this amount of dB louder than the bone-conduction threshold of the opposite ear in order for the sound to be detected by the opposite ear. With insert earphones, the interaural attenuation is around 55 to 75 dB.

When measuring the bone-conduction threshold, the attenuation is 0 dB because the vibrations immediately propagate through the skull to the cochlea of the opposite ear. In order to determine the bone-conduction threshold on the test ear, the hearing on the non-test ear must always be masked.

SPEECH AUDIOMETRY

The ability to hear and understand speech is essential to our communication with those around us. The two measurements most frequently used to assess speech intelligibility are:

- Speech reception threshold measurement
- Speech recognition measurement

Speech reception threshold

The speech reception threshold, which is abbreviated SRT, is the softest level at which the client can identify and repeat 50% of the words from a list presented through earphones. The word list often consists of commonly used words with one or more syllables. The words can also be numerals. The speech reception threshold is expressed in dB HL.

As the speech reception threshold depends on the hearing thresholds of the test ear, the speech reception threshold will usually coincide with the average of the air-conduction thresholds for 500 Hz, 1000 Hz and 2000 Hz. The audiologist can therefore use the speech reception threshold to check the audiogram at these frequencies.

Speech recognition

Speech recognition is measured by presenting words at a sound level where they are clearly audible to the test person. The test person is asked to repeat all the words. At the end of the test, the percentage of correctly identified words is calculated as a score. Speech recognition is also referred to as speech intelligibility or speech discrimination.

The speech reception threshold is the level at which a person can identify 50% of the words from a list of presented words.

Speech recognition is often measured in quiet and noise to determine the hearing impaired person's ability to understand speech.

UNCOMFORTABLE LOUDNESS AND MOST COMFORTABLE LOUDNESS

The Uncomfortable Loudness Level, abbreviated UCL, is the upper limit of the dynamic range of hearing, and is the level at which sound is perceived to be uncomfortably loud by the listener. The UCL level is measured by presenting recordings of loud speech or other test signals to the client. The client is instructed to indicate when the loudness level becomes uncomfortably loud. The UCL levels vary from one person to another, usually they lie in the range from 100 to 120 dB HL. This type of measurement has a low test-retest reliability because the test results are influenced by a number of factors, such as the instructions given to the test person.

Sometimes the level at which sound is judged to be most comfortable by the test person, called the Most Comfortable Loudness (MCL), is also measured. The MCL level lies between the hearing threshold and the uncomfortable loudness level. The Most Comfortable Range (MCR) is the range of levels within which sound is perceived to be comfortable.

PHYSIOLOGICAL MEASURES

In the previous sections measures for subjective perception of the test signal were presented. Hearing health-care professionals also use objective measures to obtain information about the test person's hearing ability as well as the middle ear and inner ear function, without the active participation of the test person.

In the following sections you can read about some common physiological measures used by hearing healthcare professionals: acoustic immittance, otoacoustic emissions and auditory brainstem response.

Acoustic immittance measures to assess middle ear function

The middle ear is an important intermediate station for the sound waves travelling to the inner ear. The middle ear houses the ossicular chain, which transfers the vibrations from the eardrum to the oval window in the cochlea. In order for the sound to be transmitted through the middle ear, the eardrum and ossicular chain must move optimally.

Middle ear infection often results in reduced middle ear pressure and fluid in the middle ear. Another disorder of the ear, otosclerosis, causes the stapes to become fixed to the oval window, which results in reduced mobility of the ossicular chain. In both cases, the ability to transmit sound through the middle ear is impaired, causing conductive hearing loss.

Middle ear function is assessed by means of an immittance meter. A tightly fitting probe is inserted into the test ear. The probe emits a low-frequency tone and varies the air pressure in the ear canal by means of a pump. The probe is connected to a small microphone which measures the sound pressure level in the ear canal. (fig. 4.12).

As ear canal air pressure increases and decreases relative to the middle ear pressure, the eardrum mobility changes. This affects the transmission of sound energy to the middle ear, and the effect can be measured as sound pressure changes in the ear canal.

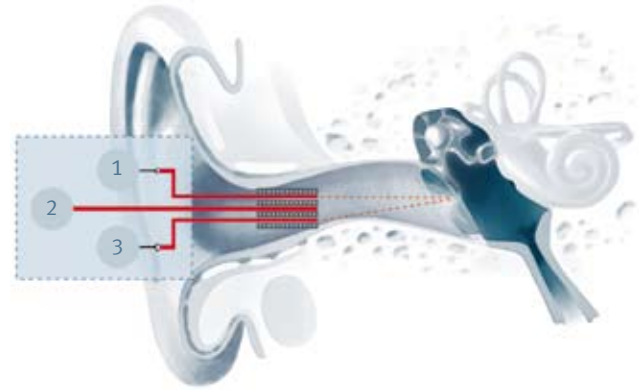

► Figure 4.12. Middle ear function is assessed with an immittance meter. 1. Loudspeaker - 2. Air pump - 3. Microphone

Tympanometry

The connection between the ear canal air pressure and the transmission of sound through the middle ear is shown on a tympanogram. The x-axis of the tympanogram represents the air pressure relative to atmospheric pressure, and the y-axis shows the transmission of sound through the middle ear (immittance) (fig. 4.13).

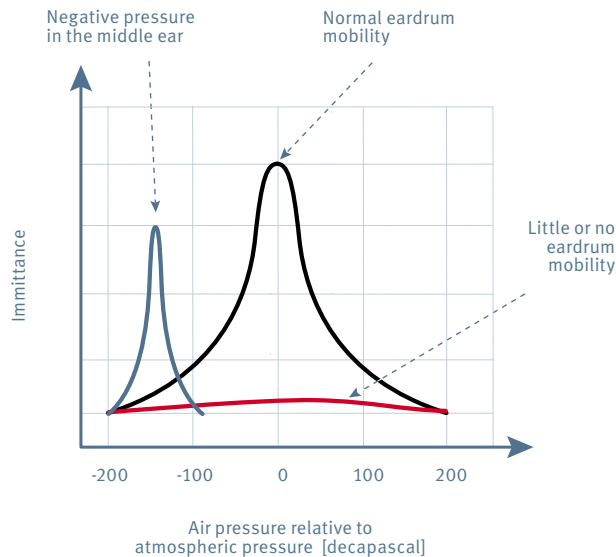

► Fig 4.13. The tympanogram shows middle ear immittance changes as a function of ear canal air pressure for different states of the middle ear.

Usually the middle ear immittance will be largest when the pressure is the same on either side of the eardrum, i.e. normal air pressure. If the middle ear pressure is negative or the middle ear system mobility is zero, this will generally be reflected in the tympanogram.

Measurement of the stapedial reflex

The immittance meter is also used to measure the stapedial reflex. The stapedius muscle reduces the sound transmission through the ossicular chain and eardrum at high levels – usually at sound levels of between 80 and 110 dB HL. See the section “The stapedial reflex” in the chapter “The auditory system” for further details.

An immittance probe is used for this measurement. The probe emits a test tone, and when the stapedial reflex is provoked, the middle ear system mobility is reduced. The result can be assessed by measuring the increase in the sound pressure of the probe tone in the ear canal.

Normally the stapedial reflex is provoked in both ears simultaneously, no matter which ear the sound is presented to. This fact can be used during the stapedial reflex measurement; the reflex can be measured on one ear while stimulating the other ear – also called contralateral stimulation (fig. 4.14).



▶ Figure 4.14. Contralateral stimulation when measuring the stapedial reflex.

In the audiogram shown in figure 4.15, a reflex provoked by contralateral stimulation is marked with ● when the right ear is stimulated, and * when the left ear is stimulated. An arrow pointing downwards from the symbol signifies that no reflex has been provoked. Note that the graphic symbols may be country-specific.

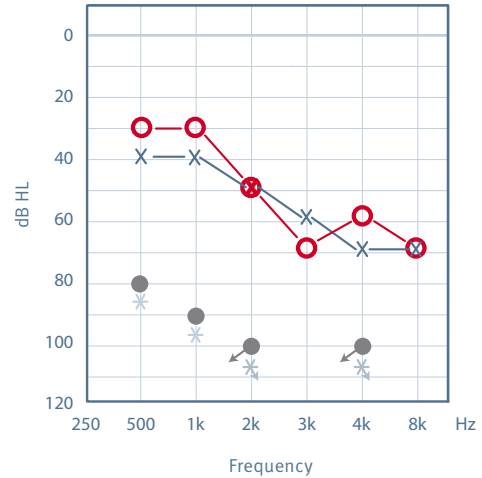

- Stapedial reflex evoked - right ear
- Stapedial reflex not evoked - right ear
- * Stapedial reflex evoked - left ear
- * Stapedial reflex not evoked - left ear

▶ Figure 4.15. The stapedial reflex is provoked at sound levels of between 80 and 110 dB HL. When the stapedius muscle contracts, tension is exerted on the ossicular chain and eardrum. This reduces the transmission of sound through the middle ear. The immittance equipment registers this effect as a sudden change of the ear canal sound pressure. The audiogram shows how the reflex is provoked in both ears at 500 and 1000 Hz, while no reflex was provoked at 2 and 4 kHz.

Otoacoustic emissions

At the end of the 1970s, the British physiologist David Kemp discovered that the inner ear is able to emit weak sound signals that can be picked up by a microphone placed in the ear canal. These sounds, called otoacoustic emissions (OAE), either occur spontaneously (spontaneous otoacoustic emissions, SOAE) or as a response to a sound sent into the ear (evoked otoacoustic emissions, EOAE).

The emissions are believed to be a by-product of the active mechanism found in the outer sensory hair cells in the cochlea.

Research shows that when the outer sensory hair cells are damaged because of, for example, pharmaceuticals, the otoacoustic emissions partly or completely disappear. Two main techniques are used for EOAE measurement. In both techniques, the emissions are produced by stimulating the ear with sound, but they differ in the type of stimulus applied:

- Transient evoked emissions (transient evoked otoacoustic emissions, TEOAE), where the cochlear response is produced by stimulating the ear with an acoustic click or tone burst (fig. 4.16).
- Distortion products (distortion product otoacoustic emissions, DPOAE), where the ear is stimulated with two tones whose frequencies are close to each other.

By analysing the cochlear response in different ways, information is obtained about the occurrence of emissions at the individual frequencies and thus the sensory hair cell function in this area of the basilar membrane.

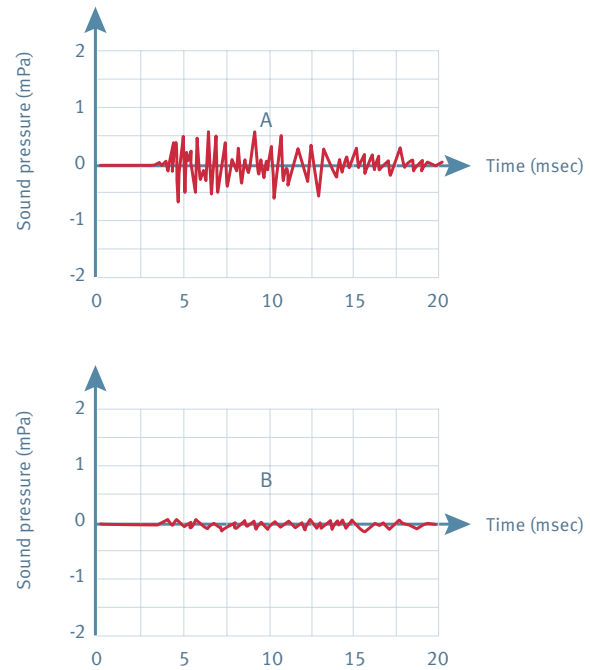

▶ Figure 4.16. Two measurements of transient evoked otoacoustic emissions: (A) shows a normal OAE measurement, which indicates normal cochlear function. (B) shows that the OAE is non-existent, which may indicate hearing loss.

The measurement of otoacoustic emissions is often a supplement to other audiometric tests. Otoacoustic emissions have proved to be able to reveal changes in the cochlear function before a hearing loss can be seen from a pure tone audiogram. This means that the measurement of otoacoustic emissions can be used, for example, to monitor whether a medical treatment has a toxic effect on the patient's hearing.

Otoacoustic emission measurements are also used in some countries to screen the hearing of newborn babies. The absence of otoacoustic emissions may be an indication that the child has sensorineural hearing loss. However, further hearing tests are recommended following this result, to diagnose if hearing loss is present.

Auditory Evoked Potentials

It is possible to measure the electrical activity that occurs in the brain when the ear reacts to sound. When a sound signal is converted into neural impulses in the inner ear, it proceeds through the auditory nerve and different nuclei in the brainstem. Each time the signal passes one of these nuclei, electrical activity is produced, which can be measured on the surface of the test person's head.

The most common method used to measure electrical activity is called Auditory Brainstem Response (ABR). Electrodes are fastened with electrically conductive material to the head of the test person. One electrode is usually placed on the forehead, and one behind each ear, either on the mastoid bone or on the earlobe (fig. 4.17).

The auditory system is stimulated with a series of sounds presented through the earphones. As electrical impulses are emitted from the auditory nerve, the potential difference between the electrode on the forehead and the electrode on the mastoid bone or ear lobe is measured.

The potential difference is very small compared to random electrical noise in the body or noise from muscular activity. However, the averaging technique – with many repeated measurements and calculation of an average – makes the voltage peaks become more evident.

The amplitude of the electrical impulses from the brainstem is shown as peaks on a time line, and a typical response to a sound consists of several peaks (fig. 4.17).

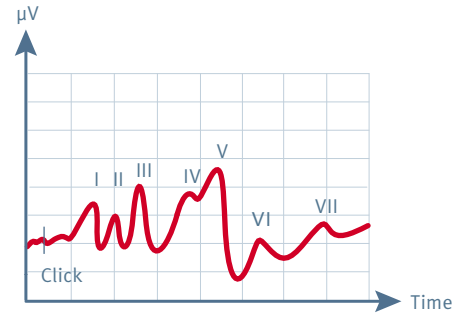

▶ Figure 4.17. The brainstem response is shown as voltage peaks with seven peaks on a time line. The peaks represent the activity in different nuclei in the brainstem.

If the peaks deviate from the normal shape, or the peaks are displaced in time, or there is no response for one or several peaks, this may be an indication of auditory dysfunction and/or hearing loss. Further tests should be carried out. The ABR method can also be used to determine physiological hearing thresholds, for example in newborn babies, or other groups of patients who cannot participate in an ordinary hearing test. Stimulation with tone impulses helps provide frequency-specific information about the hearing thresholds.

In recent years, a new measuring method called Auditory Steady State Response (ASSR) has been introduced. Instead of clicking sounds, modulated pure tones are used as stimuli. With this method, it is possible to obtain frequency-specific information about the hearing thresholds at the individual frequencies. The method also enables the testing of several frequencies in both ears simultaneously, thereby reducing test time.

CALIBRATION OF AUDIOMETRIC EQUIPMENT

An important requirement for all types of audiometric tests is that the equipment used is calibrated. Calibration serves to verify that the relation between the SPL delivered by the earphone and the HL displayed on the audiometer is in accordance with applicable standards.

Calibration of earphones

The calibration of earphones for audiometric purposes is described in various international standards like ISO, ANSI and IEC. These standards lay down threshold values in dB SPL in an acoustic coupler, often called an artificial ear or ear simulator, for the types of earphones commonly used by hearing healthcare professionals world-wide.

The threshold values have been calculated by measuring the hearing threshold under earphones in a major group of test persons with normal hearing, and then calculating the average audiometer setting at the individual frequencies. Afterwards the earphone has been connected to a coupler and the corresponding sound pressure level (dB SPL) in the coupler has been measured. This sound pressure level is also called the reference equivalent threshold sound pressure level in a specific coupler (RETSPL).

During a calibration, the earphone is connected to a coupler which corresponds to a type specified in the standards. The audiometer sends a test tone to the earphone, and the sound pressure in the coupler is measured with a sound level meter. The audiometer is calibrated in such a way that 0 dB HL gives a sound pressure corresponding to RETSPL for the different frequencies (fig. 4.18).



► Figure 4.18. The earphone is mounted on a coupler, and the audiometer is calibrated so that 0 dB HL corresponds to the RETSPL value for the different frequencies. The sound level meter measures the sound pressure in the coupler.

Calibration considerations

A very common type of coupler used for calibrating earphones has a volume of 6 cm^3 , which corresponds more or less to the volume under the earphone on a real ear. The volume has been chosen to simulate the acoustic conditions that exist under earphones at a hearing test, and the values for the reference threshold RETSPL should, in principle, reflect the sound pressure at the eardrum of a real ear.

However, the fact that the earphones are calibrated on a standardised coupler according to the average hearing threshold of a major population results in some inaccuracy. One reason for this is that the acoustic conditions of an average ear can only be approximated with the coupler and another is that the ear canal volume can vary considerably from ear to ear; finally the result also depends on how tightly the earphone fits the ear. This means that the actual sound pressure at the eardrum – and thus in the measured thresholds – may deviate by as much as 15 to 20 dB, especially at low and high frequencies.

This inaccuracy may cause problems when determining the required hearing aid amplification. In this case, it would be an advantage to be able to measure the hearing thresholds under the acoustic conditions created when the hearing aid is placed in the ear.

A series of thin, light gray wavy lines that flow across the page from left to right, creating a sense of movement and depth. The lines are layered, with some appearing in front of others, and they all seem to originate from a point on the left side of the page.

[CHAPTER 5]

PROGRESS IN HEARING AID DEVELOPMENT



CHAPTER 5

PROGRESS IN HEARING AID DEVELOPMENT 103

Hearing aid history **103**

 The basic principle of a hearing aid **103**

Hearing aids and technologies over the past 100 years **104**

Programmable analogue hearing aids **108**

From linear to nonlinear amplification **110**

Digital hearing aids **113**

Hearing aid fitting using fitting rules **115**

 Basis for generic fitting rules **115**

 Lybarger's procedure **115**

 National Acoustic Laboratories procedure (NAL) **116**

 Desired Sensation Levels procedure (DSL) **116**

Incorporation of nonlinearity into generic fitting rules **116**

Fitting rules – before and now **117**

PROGRESS IN HEARING AID DEVELOPMENT

The introduction of progressively more sophisticated hearing aids and new adjustment possibilities created a demand for procedures and rules for fitting hearing aids. Some of the generic and hearing aid specific fitting rules are described in the following sections.

This chapter also deals with the transition from linear to nonlinear amplification. Nonlinear amplification marked the beginning of a new era in hearing aid technology by considerably improving sound quality and listening comfort.

Hearing aid history

The ability to hear is very important for communication with people around us. Hearing impairment may affect the hearing impaired person, their families, and their friends in many ways. Hearing impaired people usually cannot be helped by medical treatment or surgery. Therefore hearing aids remain the most satisfactory solution for improving people's quality of life.

The basic principle of a hearing aid

In principle, a hearing aid carries out the following functions:

- Conversion of sound into electrical signals
- Signal processing of these electrical signals
- Conversion of these electrical signals back into sound



The microphone picks up surrounding sounds and converts them into electrical signals. From the microphone, the signals are sent on to the amplifier of the hearing aid. In the amplifier, the signals are processed and amplified. Some hearing aids have a volume control, which allows the user to adjust the volume of the amplified sound manually. The receiver is another name for the tiny loudspeaker that delivers the amplified sound to the ear. For a more detailed description of hearing aid components, see the chapter “Hearing aid components”.

Hearing aids and technologies over the past 100 years

Figure 5.01 provides an example of how the increasing integration of the electronic components has affected the size of the individual hearing aid component.

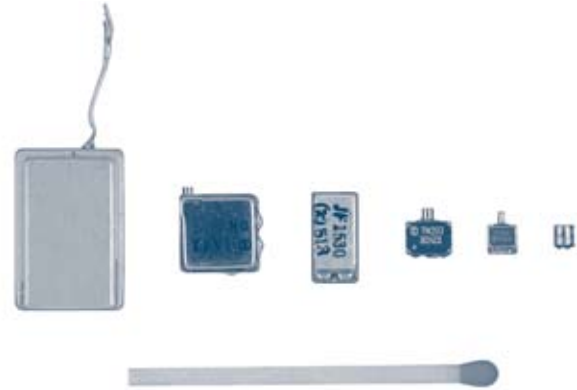

▶ Figure 5.01. Example of how the technological development has affected the size of hearing aid components. Due to advances in the electronics field, it has been possible to reduce the size of a microphone by more than 95% compared to its size in 1955.

The first electronic hearing aids were introduced at the beginning of the 20th century. In these hearing aids, the sound was amplified by means of carbon membranes that varied the electrical battery voltage. The electronic hearing aids were relatively large, and the sound quality was not particularly good. These hearing aids could only be used for mild and moderate hearing losses

The invention of the vacuum tube in the 1930s marked the next period in hearing aid technology. In vacuum-tube hearing aids, small voltage variations from the hearing aid microphone controlled an electron flow through the vacuum radio tube. By connecting several vacuum tubes in series, the signal could be amplified by up to 70 dB (fig. 5.02).



▶ Figure 5.02. Hearing aid with a vacuum tube amplifier. The hearing aid was powered by two batteries.

Around 1954, the vacuum tubes were replaced by transistors. The transistor was developed on much the same principle as the vacuum tube, but the size and current consumption of the transistor were considerably reduced. This made it possible to make the hearing aids so small that they could be fitted into a small box, which could be carried in a pocket or hung from the neck – the so-called body-worn aid (fig. 5.03).



▶ Figure 5.03. Widex 561 body-worn hearing aid from 1956. The microphone, amplifier and batteries are encased in a box, and a cord conducts the amplified signal to a receiver clicked onto a custom-made earphone.

Late in the 1950s, the first behind-the-ear hearing aids were introduced. They were often built into spectacle frames – the so-called spectacle hearing aids or hearing glasses (fig. 5.04).



▶ Figure 5.04. Widex' first behind-the-ear hearing aid and a spectacle hearing aid from around 1960.

As hearing aid technology improved, the size of the hearing aid components was reduced, and signal processing became still more sophisticated. By the middle of the 1960s, it became possible to integrate circuits into hearing aids. An integrated circuit (IC) – which is also called a chip or a microprocessor – is a semiconductor that contains many small resistors, capacitors and transistors. The hearing aids were equipped with several trimmers, allowing the hearing aid specialist to adjust amplification, maximum output and amplification roll-off in the low and high frequencies (fig. 5.05).



▶ Figure 5.05. Widex A1 hearing aid from 1972 with trimmer controls.

Towards the end of the 1970s, in-the-ear (ITE) instruments became more frequently used. This hearing aid type was introduced at the end of the 1950s, but was not widely used, mainly due to its large size. Two decades later, however, the size of in-the-ear hearing aids had been reduced so much that they could be placed flush with the outer ear. From the 1980s and onwards, many more in-the-ear than behind-the-ear models were sold worldwide – a trend that continues (fig. 5.06).



▶ Figure 5.06. Audilens 835, the first Widex in-the-ear hearing aid from 1983.

Programmable analogue hearing aids

The first digitally programmable analogue hearing aids appeared on the market in the mid-1980s. These hearing aids contained a microprocessor that controlled the analogue signal processing in the hearing aid.

In contrast to conventional analogue hearing aids, which were adjusted by trimmers and a screwdriver, the microprocessor made it possible to adjust the hearing aid digitally from an external computer or a hearing aid programmer. New fitting methods using the individual hearing aid's specific features were developed. The idea that a hearing aid could not stand alone, but was part of the hearing aid fitting process, started to gain ground.

Digital control of the analogue components provided the possibility of programming the hearing aids and allowed the use of fitting rules based on computations. The hearing aids could also have several listening programs selectable via a remote control (fig. 5.07).



► Figure 5.07. The Quattro hearing aid from Widex was a programmable analogue instrument. Its four programs could be selected via a remote control.

In 1993, a group of hearing aid manufacturers founded an association called HIMSA (Hearing Instrument Manufacturers' Software Association). The objective of the association was to make it easier to fit hearing aids in general. Under the auspices of HIMSA, a software platform called NOAH was created. Around the same time a standardised interface box called HI-PRO (Hearing Instrument Programmer) was designed (fig. 5.08). In 2003, NOAHlink was introduced to replace the HI-PRO interface box. NOAHlink utilises Bluetooth technology to facilitate high-speed wireless hearing aid programming.



▶ Figure 5.08. A PC and a HI-PRO box. As the hearing aid is connected to the HI-PRO box, it can be programmed via the PC.

With this equipment, the hearing aid specialist can fit all types of hearing aids from the same software platform (fig. 5.09).



▶ Figure 5.09. A NOAHlink with Bluetooth technology in use.

From linear to nonlinear amplification

Until the beginning of the 1970s, amplification in all commercially available hearing aids was linear, which means that amplification is the same for all sounds – soft or loud. This principle applies to sound levels up to the maximum output level. Even when the sound exceeds the maximum allowable input level, it cannot be amplified beyond the maximum output level.

In linear amplification, the amount of amplification is the same for soft and loud sounds.

In the 1970s, hearing aid manufacturers started to work with compression or automatic gain control (AGC) to achieve nonlinear amplification. Contrary to a linear amplifier, which always provides the same amplification for all input levels, the amplification in a nonlinear hearing aid changes as a function of the sound input level.

In nonlinear amplification, the amount of amplification changes according to the current input level. This means that the amplification depends both on the input level and on the frequency response of the hearing aid. Initially, compression was primarily used at high hearing aid output levels to prevent sound distortion (also called peak clipping) at the hearing aid's maximum output limit. This kind of compression is also known as output-limiting.

In the first hearing aids with nonlinear amplification, the compression could either be output-controlled (also called AGC-O) or input-controlled (called AGC-I). The difference between the two types of compression relates to the position of the compression circuit in the signal pathway. In a hearing aid with AGC-O compression, the compression circuit is located after the hearing aid volume control. This means that the maximum output limit of the hearing aid will always be the same, no matter which volume setting the user chooses. In hearing aids with AGC-I compression, the compression circuit is located before the volume control, which means that the maximum output will change as the user turns up or down the volume.

Nonlinear amplification has made it possible to use compression mechanisms to match the hearing aid output to the sound perception of the hearing impaired user. Sensorineural hearing loss is often accompanied by loudness recruitment, which means that a given sound level increase is perceived to be far greater by the hearing impaired person than by someone with normal hearing.

Loudness recruitment means that a person with hearing loss perceives increases in sound level in just above the hearing threshold to be far greater in loudness than someone with normal hearing.

The loudness recruitment phenomenon is illustrated in figure 5.10. The hearing loss depicted is 60 dB HL, and the loudness curve for the sensorineural loss is steeper than the loudness curve for normal hearing.

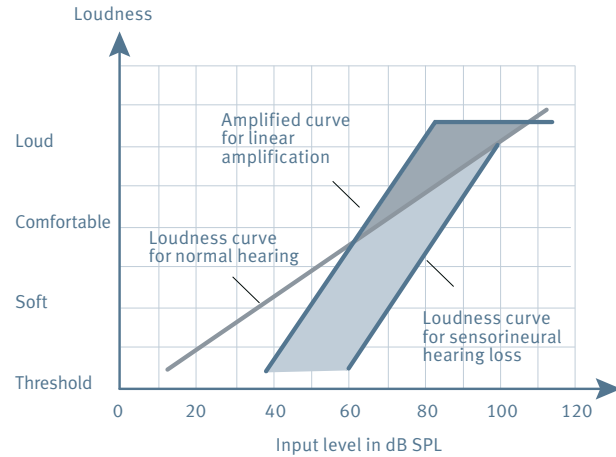

► Figure 5.10. Loudness recruitment with linear amplification in relation to the loudness perception of a person with normal hearing. Only input levels of 60 dB SPL match the loudness curve of the person with normal hearing.

The figure 5.10 also shows the amplification in a linear hearing aid, which is the area between the Loudness curve for sensorineural hearing loss and the Amplified curve for linear amplification. The hearing aid user's hearing ability is improved due to the amplification, but the loudness perception is still abnormal compared to that for normal hearing, shown as the Loudness curve for normal hearing.

With linear amplification it is only possible to obtain a match on one point on the normal loudness curve, in this case with an input level of around 60 dB SPL. Input levels above this level will be perceived to be louder and input levels below to be softer than would be the case with normal hearing. As a result, users of linear hearing aids often have to adjust the hearing aid volume control in different listening situations to obtain a comfortable sound level.

By compressing the amplified signal it is possible to better match normal loudness perception for the hearing aid user. This is also called loudness normalisation, and is illustrated in figure 5.11.

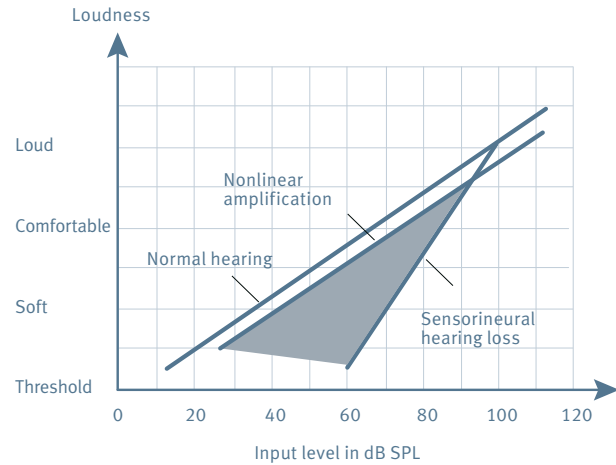

► Figure 5.11. In a hearing aid with nonlinear amplification, the dynamic range of the input is compressed to ensure that the amplification is always close to normal loudness perception.

The output is compressed, and the amplification, which is illustrated by the coloured area, decreases with increased input levels. At an input level of 100 dB SPL, no amplification is provided as the loudness perception for the person with hearing loss is the same as for the person with normal hearing.

This kind of compression is called Wide Dynamic Range Compression (WDRC), because it works over a large part of the dynamic input range.

Digital hearing aids

Digital programming opened up many new possibilities for adjusting analogue hearing aids, but the lack of precision, and the internal noise and battery consumption of the analogue components eventually became barriers to more sophisticated hearing aid design. The designers therefore turned their attention to digital signal processing technology.

A digital hearing aid is actually a microcomputer which processes and amplifies incoming signals. The first commercially successful fully digital hearing aid, Senso by Widex, was launched in 1996 (fig. 5.12).

Digital signal processing allows flexible processing, without many of the constraints associated with analogue technology. With the use of digital technology, a hearing aid can be fitted for many different types of hearing loss and it is possible to use far more advanced audiological principles – to the benefit of the hearing aid user.

A digital hearing aid is characterised by fully digital signal processing. The analogue input signal from the microphone is converted into digital form for further processing and digital amplification in the hearing aid microprocessor. The sound can be split up into several separate frequency channels, which each apply a channel-specific degree of amplification and further processing. Then, the signal is converted back to analogue form at the final stage of the hearing aid and delivered to the receiver.

For a more detailed description of the hearing aid components, see the chapter “Hearing aid components”. Further information on signal processing, goals and operation can be found in the chapter “Signal processing”.



► Figure 5.12. Widex Senso in-the-ear instrument and chip. The chip is the “heart” of the hearing aid, because this is where signal processing takes place.

The development of hearing aids goes back a long time. The overview below illustrates the times when the different hearing aid types appeared on the market. There is a clear trend towards the use of digital technology in hearing aids.

▶ Figure 5.13 . The progress of hearing aid technology over the past 100 years.

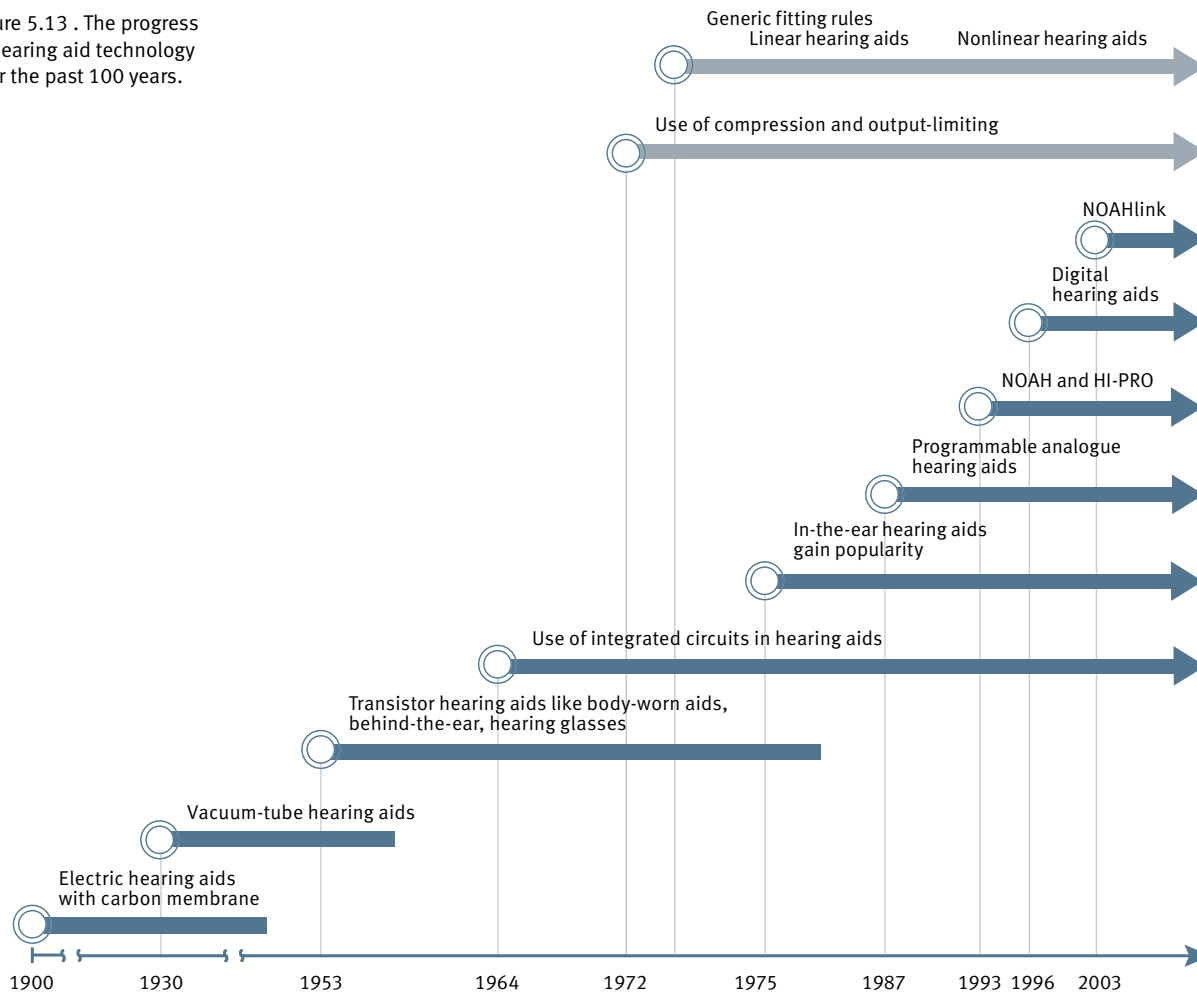

Hearing aid fitting using fitting rules

With more and more adjustment possibilities opening up, the focus on individual hearing aid fitting increased. Throughout the 1970s and 1980s, several groups of researchers worldwide started to develop so-called generic fitting rules, by which hearing aid amplification could be determined on the basis of the user's hearing threshold. The term generic refers to the fact that the rule can, in principle, be used to fit any hearing aid available on the market.

As electronic development in hearing aid design accelerated, the generic fitting rules moved out of focus. Some hearing aid manufacturers now use hearing aid-specific fitting rationales for digital hearing aids for the purpose of optimising sound quality, listening comfort and speech intelligibility for the hearing aid user. This optimisation of the specific hearing aid's amplification and signal processing according to current research results and electronic design is ensured in the development process by the manufacturers' audiological competence.

A presentation of the most common generic fitting rules and a description of the factors that apply when determining the amplification for different types of hearing loss are provided in the following sections.

Basis for generic fitting rules

The first generic rules based the prescribed formulas for calculating amplification targets on the degree of hearing loss at individual frequencies. These targets were used when adjusting the hearing aid.

Some common generic fitting rules for linear hearing aids are:

- Lybarger's procedure
- National Acoustic Laboratories procedure (NAL)
- Desired Sensation Level procedure (DSL)

Lybarger's procedure

In 1944, Lybarger suggested a procedure which has later become known as the half gain rule. The procedure prescribes that the recommended amount of amplification measured in a 2-cc coupler should be half the value of the hearing impaired person's hearing loss.

National Acoustic Laboratories procedure (NAL)

The NAL procedure was developed by the National Acoustic Laboratories in Sydney, Australia. The first version of the NAL procedure appeared in 1976. The essence of the procedure was that speech at ordinary voice level should be presented at the user's most comfortable loudness (MCL) level so that it was comfortably loud. To optimise speech intelligibility, speech was amplified so that all parts of the speech spectrum were equally loud (loudness equalisation).

Desired Sensation Levels procedure (DSL)

The DSL procedure from 1983 was developed at the University of Western Ontario in Canada. The goal of the DSL procedure was to amplify speech at ordinary voice level so as to make all parts of the speech spectrum audible to the client. Simultaneously, the speech loudness level should be comfortable, and the hearing aid output should never exceed the uncomfortable loudness (UCL) level of the hearing impaired person.

Incorporation of nonlinearity into generic fitting rules

The generic fitting rules also changed significantly after the introduction of nonlinear amplification. Several generic rules were launched throughout the 1990s which prescribed amplification in nonlinear hearing aids. The aim was to set up common standards for the parameters used for nonlinear hearing aids.

The NAL and DSL procedures have been revised so as to be able to prescribe nonlinear amplification. Both fitting procedures are now available as computer programs. The hearing aid dispenser can enter the user's hearing thresholds in these programs, after which the programs calculate the targets for the hearing aid amplification taking into account different input levels, compression parameters and ratios.

In some cases, hearing aid manufacturers have joined forces with designers of generic procedures to be able to use these procedures in their own fitting software.

Widex has developed specific fitting rules, which suit the electronic characteristics of each hearing aid series. Research has shown that the UCL level and MCL level can be predicted on the basis of the hearing threshold. These findings and research results from NAL, as well as clinical trials, form the basis of Widex fitting rules.

Fitting rules – before and now

The fitting procedures presented in this chapter aim at amplifying speech so as to make it audible to the user at a comfortable sound level. Still, the amount of amplification prescribed in the presented procedures differs somewhat, especially at high frequencies. This means that there are various suggestions as to what the optimum amplification should be for a given hearing loss.

In the mid-90s, some of the major hearing aid manufacturers began developing hearing aid-specific fitting rationales. Audiological and electronic experts collaborated to establish a rationale that could deliver the best sound quality, listening comfort and speech intelligibility. The introduction of hearing aid-specific fitting rules was considered necessary due to the new signal processing technology and new audiological knowledge about loudness perception in people with hearing loss.

A series of thin, light gray wavy lines that flow across the page from left to right, creating a sense of movement and depth. The lines vary in amplitude and frequency, with some having larger peaks and others being more subtle.

[CHAPTER 6]
HEARING AID TYPES



CHAPTER 6

HEARING AID TYPES 121

Behind-the-ear hearing aids 122

In-the-ear hearing aids 123

 Full concha or half concha 123

In-the-canal 124

Completely-in-canal 124

Other hearing aids 125

Feedback whistling 126

Special hearing aid systems 126

 CROS and BiCROS 126

 Spectacle hearing aids 129

 Bone-conduction hearing aids 129

 Bone-anchored hearing aids 130

 Tinnitus instruments 131

 Middle ear implants 131

 Cochlear implants 132

HEARING AID TYPES

Modern hearing aids come in several styles. The choice of model depends on various factors, like the degree of hearing loss, the dimensions of the ear and ear canal, the user's ability to operate the hearing aid, and the user's individual needs and preferences.

Hearing aid models can be divided into five types.

- Behind-the-ear hearing aids
- In-the-ear hearing aids
- In-the-canal hearing aids
- Completely-in-canal hearing aids
- Other hearing aid types

In the following sections, we describe the main characteristics of the various hearing aid types.



Behind-the-ear hearing aids

A behind-the-ear (BTE) hearing aid consists of two parts: the hearing aid itself, which hangs behind the ear, and an earmould formed to fit into the ear. The earmould is custom-made on the basis of a silicone impression of the client's outer ear and ear canal (fig. 6.01).

The amplified sound from the hearing aid is directed to the earmould through a plastic tube and further on into the ear through the sound bore of the earmould.



▶ Figure 6.01. A BTE hearing aid, which is used together with an earmould.

BTE hearing aids come in different sizes and shapes. Manual controls are located on the top side of the instrument. The controls can be manipulated with a forefinger and thumb. In general, the more powerful the hearing aid is, the larger it is, because a larger battery and receiver are required.

BTE instruments are often used for clients whose hearing thresholds exceed 70 dB HL, or when it is most practical for the client to wear the hearing aid behind the ear. Moreover, more options are usually available with BTE instruments than with in-the-ear instruments, for example a direct audio input feature to be used to connect assistive listening devices.

In-the-ear hearing aids

A characteristic feature of in-the-ear hearing aids is that all the electronic components of the instrument are contained within the plastic shell that fits into the ear (fig 6.02).

The microphone, battery compartment and user controls are located on the faceplate positioned at the opening to the ear. The hearing aid receiver positioned in the ear canal is often protected by a wax guard designed to prevent ear wax from blocking the receiver.

In-the-ear hearing aids are available in different models:
Full concha or half concha

Full concha or half concha

The largest in-the-ear model is called a full concha hearing aid. The full concha model occupies most of the concha of the outer ear. A variation of this model is called a half concha and is characterised by being smaller.



▶ Figure 6.02. An ITE hearing aid is a custom-made instrument that fits in the ear and is placed in the concha and ear canal.

In-the-canal

A canal or in-the-canal (ITC) hearing aid is a smaller version of an ITE hearing aid. It is placed partially in the ear canal, but its faceplate is still visible (fig. 6.03).



▶ Figure 6.03. An ITC hearing aid is an instrument that is made to fit in the ear canal.

Completely-in-canal

The smallest model is a completely-in-canal (CIC) hearing aid. This model is placed deeply in the ear canal. A small extraction cord is attached to the outside of the aid so that the user can easily take it out of the ear. CIC hearing aids are often fully automatic (fig. 6.04).



▶ Figure 6.04. As the CIC hearing aid is worn deep in the ear canal, it is barely visible. The hearing aid is provided with an extraction cord for easy removal of the aid.

As is the case with BTE aids, there is a relationship between the size of the aid and the degree of amplification provided. CIC aids are generally only suited to mild and moderate degrees of hearing loss. The reasons for this are that they use a small battery, and the receiver is only able to provide a limited output sound pressure level. An advantage of CIC hearing aids, however, is that the outer ear's natural ability to pick up sound is maintained. This provides extra amplification at high frequencies and facilitates sound source localisation.

Because a CIC hearing aid is placed deeper in the ear canal than other hearing aid types, the cavity between the hearing aid and the eardrum is reduced. As a result, a suitable output sound pressure level can be obtained with a lower receiver signal level than in other hearing aids.

Other hearing aids

For many years, the hearing aid microphone and amplifier were placed in a small box worn around the neck, on a belt or in a pocket – also called a body-worn hearing aid. Hearing aids of this type are still available, but are only used for very severe degrees of hearing loss or by people who cannot operate other hearing aid types (fig. 6.05).

A cord conducts the signal from the aid to the ear, where the hearing aid receiver is separately mounted on a custom-made earmould.



► Figure 6.05. A body-worn hearing aid. It consists of an earmould and the hearing aid itself, which is worn around the neck, in a pocket or on a belt.

Feedback whistling

Common to all hearing aid models is the risk of feedback whistling. Due to the short distance between the receiver and the microphone, amplified sound may sometimes escape and leak back into the hearing aid microphone, resulting in annoying feedback whistling.

To avoid feedback, it is important that the earmould or shell fits tightly in the ear, and that the hearing aid vent size is adjusted to the degree of hearing loss. More information on venting is available in the chapter “Earmoulds and shells for hearing aids”. Modern hearing aids use different kinds of systems to reduce or eliminate feedback whistling.

Special hearing aid systems

CROS and BiCROS

People with severe unilateral hearing loss often experience problems in localising sound and hearing speech in background noise – for example when having to communicate at a dinner party with the person sitting to the side where the hearing is poorest.

A CROS (Contralateral Routing Of Signal) system is used when the client has a high degree of hearing loss or is deaf in one ear, but has normal or almost normal hearing in the other ear.

A hearing aid case only containing a microphone is placed on the poorer ear. The sound picked up by the microphone is routed to the amplifier and receiver mounted at the better ear at the opposite side of the head, either using a wireless link or a thin cable. The receiver at the better ear reproduces the sound picked up at the poorer ear. This way, the better ear hears sounds picked up at both sides of the head. The hearing aid on the better ear often has a volume control to enable the user to adjust the volume of the transmitted signal (fig. 6.06).

The hearing aid on the better ear has a large vent allowing sounds coming from this side of the head to directly enter the better ear.

As sounds from both sides of the head are heard in the better ear, it can sometimes be difficult for the user to distinguish between the sound transmitted from the poorer ear and the sound coming directly into the better ear.



▶ Figure 6.06. A CROS system is used by people with a unilateral, severe degree of hearing loss. The sound from the almost deaf ear is routed to the ear with almost normal hearing.

If a client has a severe degree of hearing loss or is deaf in one ear, and has a moderate hearing loss in the other ear, he or she can benefit from a BiCROS (Bilateral Contralateral Routing Of Signal) system. The system is similar to the CROS system, except that there is also a microphone on the better ear. This is typically a regular hearing aid with the additional input from the microphone placed at the poorer ear (fig. 6.07).

In this way, sounds from both sides are transmitted to the better ear. Both the transmitted sound from the poorer ear and the sound from the better side are amplified according to the hearing loss in the better ear.



- ▶ Figure 6.07. A BiCROS system is used by people who are almost deaf on one ear and have a hearing loss in the other ear. The sound from the poorer ear is transmitted to the better ear, where it is amplified along with the sound entering the better ear, to compensate for the hearing loss.

Spectacle hearing aids

The first hearing aids that could be worn at the ear were mounted on spectacle frames. Spectacle hearing aids are still occasionally used (fig. 5.04).

Also used today are BTE hearing aids mounted on spectacle frames by means of an adaptor. The adaptor is fastened to the hearing aid sound outlet, and a tube directs the sound via the adaptor to an earmould in the ear (fig. 6.08).



► Figure 6.08. A BTE hearing aid mounted on spectacle frames by means of an adaptor. The sound is transmitted to the ear through the adaptor, tube and earmould.

Bone-conduction hearing aids

There are some people with conductive or mixed hearing loss who cannot, for one reason or another, wear a conventional hearing aid that is coupled to the ear canal. The reason could be a deformation of the ear canal that blocks the sound transmission, or a perforated eardrum, in which case blocking of the ear with an earmould is to be avoided due to the risk of infection. In these cases, a bone-conduction hearing aid can sometimes be used instead of a conventional hearing aid to compensate for the hearing loss. The transducer, which is known as a bone conductor, directly vibrates the skull. These vibrations are transmitted instantly to the cochlea.

There are two types of bone-conductor systems. One type consists of a hearing aid attached to a headband. At the other end of the headband, a bone conductor is mounted. The headband is positioned on the head so that the bone conductor presses against the mastoid bone behind the ear.

Alternatively, the bone conductor can be mounted on one of the arms of a spectacle frame along with a microphone, battery and amplifier. When the client puts on the glasses, the bone conductor presses against the mastoid bone behind the ear.

Bone-anchored hearing aids

If a client with conductive hearing loss will never be able to benefit from a conventional hearing aid, an alternative could be to use a bone-anchored hearing aid, BAHA.

The bone-anchored hearing aid is coupled to a screw-shaped titanium implant in the skull. The hearing aid components are contained in a small detachable housing. When the hearing aid is coupled to the implanted titanium screw which is positioned behind the ear, mechanical vibrations from the hearing aid are transmitted to the skull and cochlea via the titanium screw (fig. 6.09).

Although a BAHA implant requires a surgical procedure, it is often preferred to the headband type of bone-conduction hearing aid, which may press uncomfortably against the head. It provides greater physical comfort and is less visible than the headband bone-conductor type.



► Figure 6.09. A bone-anchored hearing aid is used where a person with conductive hearing loss will never be able to benefit from a conventional hearing aid.

Tinnitus instruments

To some people with tinnitus (ringing or other sounds in the ears), the tinnitus noise is so annoying that their quality of life is reduced. They may experience sleeping difficulties, anxiety, lack of concentration as well as general difficulties in ignoring the tinnitus noise.

Some people with tinnitus can benefit from using a hearing aid that amplifies external sounds. As the tinnitus tone is not amplified, it is less noticeable than the amplified external sounds. People suffering from tinnitus can also use a tinnitus masker, which is an electronic hearing instrument designed to emit a specific sound. A volume control enables the client to turn up and down the volume of this sound.

The purpose of the masking sound is to mask the presence of tinnitus and give the client a more comfortable sound to listen to. The volume control of the masker can be set to drown the tinnitus noise or set to the same level as the tinnitus sound. Some therapists use tinnitus maskers to shift the client's attention from the tinnitus noise to sounds in the client's environment.

Some hearing aids provide ordinary amplification combined with a masking sound – a so-called tinnitus instrument. These hearing aids are especially suited to users who have a hearing loss in addition to tinnitus. The masking sound can be made available as a separate listening program which the user can activate and deactivate as desired.

Middle ear implants

A middle ear implant is a hearing aid arrangement in which the hearing aid receiver or the entire hearing aid is surgically inserted into the middle ear cavity.

The receiver, which is also called output transducer, is fixed either to the ossicles, the round window or the eardrum in the middle ear; the middle ear implant drives the movement of the ossicles or cochlear fluid, in response to sound.

Implantable hearing aids make up a relatively small share of the total hearing aid market. A major reason for this is that the fitting of these hearing aids requires a surgical procedure.

Cochlear implants

The cochlear implant (CI) is a special type of implantable hearing device, which may enable those with profound hearing loss to perceive sound.

It is not considered a traditional hearing aid as it is based on a different technology using a signal processor to convert external sound signals directly into electrical impulses, which then are transmitted to the auditory nerve through a multi-electrode array implanted in the cochlea.

The sound that the client hears through the implant can best be described as an artificial and approximate reproduction of the original sound picture – the sound reproduction is sufficiently good to enable some clients to hear and understand speech partially after a period of practice.

A series of thin, light gray wavy lines that flow across the page from left to right, creating a sense of movement and depth. The lines are layered, with some appearing in front of others, and they all converge towards the right side of the page.

[CHAPTER 7]
HEARING AID COMPONENTS



CHAPTER 7

HEARING AID COMPONENTS 137

OVERVIEW OF HEARING AID COMPONENTS 139

Hearing aid input 139

Microphone 139

Omnidirectional microphones 141

Directional microphones 141

Telecoil for use with loop systems 143

Audio and FM input 144

Conversion from analogue to digital form 144

Sampling frequency 145

The importance of the bit number in the binary numeral 146

Example of calculation of signal-to-noise ratio 146

Robust bit flow 147

A/D converter 147

Amplification and signal processing 147

Considerations for developing signal processors 148

Open-platform generic DSP 149

Specialised off-the-shelf DSP 149

Custom DSP 149

Amplifier types 149

Circuit board amplifier 150

Thin-film amplifier 150

Thick-film amplifier 151

Electronic filters and their implementation 151

Low-cut filter 152

High-cut filter 152

Division of the sound spectrum in multiple-band filters 153

Implementation of filter bands 153

Conversion from digital to analogue form 154

Receiver output 155

Hearing aid controls 156

Volume control 156

On/off switch 156

Telecoil switch 156

Listening program button 157

Remote control 157

Hearing aid batteries 157

Performance through high and stable operating voltage 158

Usage pattern and battery lifetime 158

Other battery types 159

HEARING AID COMPONENTS

A hearing aid comprises the following main components: a microphone, an amplifier/signal processor, a receiver, also called a loudspeaker, and a battery, supplying the hearing aid with power (fig. 7.01).

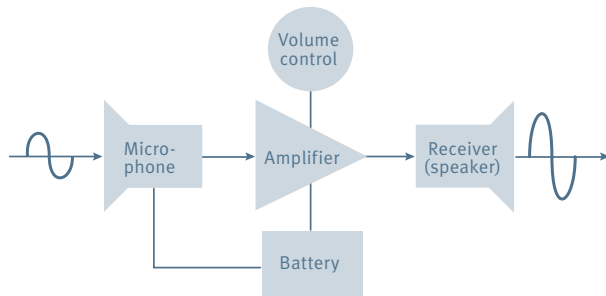

► Figure 7.01. Block diagram with the main components of a hearing aid.

The microphone picks up sounds from the surroundings and feeds them to the amplifier/signal processor, where they are amplified. The amplified signal is sent on to the receiver and then delivered to the ear.

Incoming sound is sent from the microphone to the amplifier, where it is processed and amplified according to the amplification needs of the hearing impaired and hearing aid settings. The amplified signal is fed to the hearing aid receiver and then delivered to the ear.

Figure 7.02 shows the main components of a behind-the-ear hearing aid.

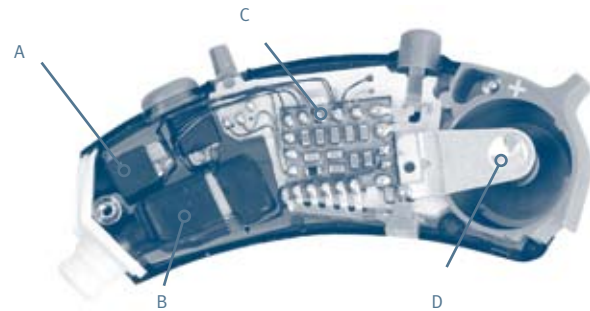

► Figure 7.02. Main components of a BTE hearing aid; microphone (A), receiver (B), amplifier/signal processor (C) and battery drawer (open) (D).

The structure of a hearing aid depends on factors such as choice of amplifier technology and type of programming and signal processing. Hearing aids come in several varieties; analogue, digitally programmable analogue and fully digital hearing aids.

Digital technology allows the use of very complex signal processing schemes involving, for example, directional microphones and different compression algorithms for optimising sound quality and speech intelligibility. The schemes make it possible to distinguish noise signals from speech signals. The noise signal is identified and attenuated. The speech sounds can then be enhanced while reducing the noise contribution. For further details about signal processing, please refer to the chapter "Signal processing".

The structure of a hearing aid also depends on hearing aid style; a BTE hearing aid is constructed differently from an ITE, ITC or CIC hearing aid. The various hearing aid styles are described in detail in the chapter "Hearing aid types". BTE instruments are factory manufactured and assembled, whereas as regards ITE and ITC instruments, only the key components, which are mounted on a faceplate, are supplied. The components of a CIC hearing aid are attached to a transport holder. The microphone, amplifier/signal processor (hereafter referred to as a hybrid amplifier), and receiver of ITE, ITC and CIC instruments are mounted directly in individually manufactured hearing aid shells (fig. 7.03).



▶ Figure 7.03. As regards ITE and ITC instruments, a faceplate with the hearing aid electronics is supplied for installation in the shell. The electronics for CIC hearing aids come attached to a transport holder.

The optimum performance of a hearing aid is highly influenced by how well the shell is manufactured and how the electronic components are mounted in the shell. Figure 7.04 shows how a faceplate is mounted in an ITE or ITC hearing aid shell.



▶ Figure 7.04. Mounting of a faceplate in an ITE or ITC hearing aid.

For more information on shell and earmould manufacturing as well as mounting of electronic components, please refer to the chapter "Earmoulds and shells for hearing aids".

OVERVIEW OF HEARING AID COMPONENTS

Although modern hearing aids are very small, they contain a large number of electronic components. The following sections describe the most important features of the key components:

- Hearing aid input
- Conversion from analogue to digital form
- Amplification and signal processing
- Conversion from digital to analogue form
- Receiver output
- Battery and battery drawer

Hearing aid input

The input transducer in a hearing aid is usually a microphone, which picks up sound and converts it into electrical signals. The sound input may also come from a teleloop system and enter the hearing aid through its telecoil. The sound input can also be a direct input in the form of an audio signal or audio input from an FM system, which is an assistive listening device used together with hearing aids for difficult listening situations, like in the classroom.

Microphone

The hearing aid microphone is basically a diaphragm that converts acoustic energy into an electrical signal. The diaphragm vibrates in response to condensation and rarefaction of air molecules from incoming sound. As the diaphragm vibrates, it creates an electrical signal that corresponds to the amplitude, frequency and phase of the acoustic signal. This electrical signal is pre-amplified before being processed in the electronic circuits of the hearing aid. As well as being sensitive to acoustic energy, the microphone is sensitive to mechanical vibrations, which can cause the microphone to generate unwanted electrical signals. Technological advancements have considerably reduced hearing aid microphones' sensitivity to mechanical vibrations, thereby reducing the risk of mechanical feedback.

It is very important to know that moisture and perspiration damage the hearing aid microphone and should therefore be prevented from entering it. When the hearing aid is used outdoor, its microphone is subject to wind noise. Wind noise contributes to the input signal and is uncomfortable for the hearing aid user. Wind noise occurs due to air turbulence close to the microphone.

The most common type of hearing aid microphone is an electret microphone. It is a special type of condenser microphone with a low-noise built-in pre-amplifier. Figure 7.05 shows a cross section of an electret microphone.

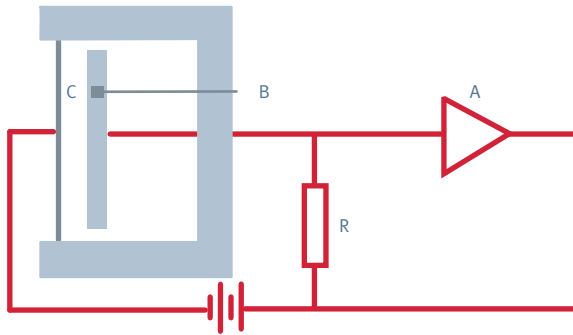

▶ Figure 7.05. Cross section of an electret microphone with a diaphragm (C), back-plate (B), preamplifier (A) and resistor (R). Air pressure fluctuations cause the diaphragm to move, generating an electrical signal which is a measure of the incoming sound pressure level.

Hearing aid microphones come in various styles with different frequency characteristics and degrees of sensitivity. The electret microphone has low sensitivity to mechanical vibrations and a flat frequency response, which means that it is suited to reproduce sounds over a wide frequency range (fig. 7.06).

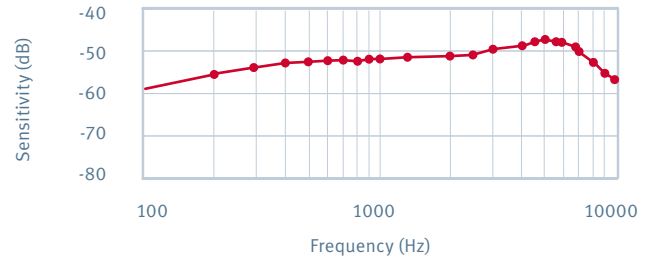

▶ Figure 7.06. Frequency response of a typical electret microphone. The relatively flat sensitivity over a large frequency range means correct sound reproduction can be achieved with relatively simple signal processing.

Instead of adjusting the frequency response by choosing a specific microphone, a common technique is now to filter the signal. This approach is preferred because it can at the same time remove part of the microphone noise in the signal. Filtration is also used to remove unwanted noise and to optimise amplification for specific frequencies or frequency bands to compensate optimally for a given hearing loss. Filtration thus improves the sound quality perceived by the hearing aid user.

Hearing aid microphones are categorised as follows:

- Omnidirectional microphones, which are similarly sensitive to sound coming from all directions (most commonly used).
- Directional microphones, which are more sensitive to sound coming from one direction than from another. Directional microphones are used to optimise speech intelligibility in noisy environments.

Omnidirectional microphones

Omnidirectional microphones are the most widely used type of microphone. An omnidirectional microphone is used in hearing aids that do not feature directivity and in CIC hearing aids, in which space is very limited. This microphone type has the same sensitivity to sound coming from all directions. The microphone has a circular directivity pattern. The greater the distance from the person (midpoint of the circle in figure 7.07), the weaker the input signal to the microphone.

An omnidirectional microphone is the most commonly used type of hearing aid microphone. It has the same sensitivity to sound coming from all directions.



▶ Figure 7.07. A person seen from above. The blue colour marks the area within which an omnidirectional microphone picks up sound.

Directional microphones

A directional microphone improves the signal-to-noise ratio for sound coming from in front of the listener. Directional microphones are used in BTE and ITE hearing aids. A directional microphone is optimised to pick up sound emanating from the front. Sound emanating from behind, as well as from the right and left sides is attenuated. In listening environments with significant reverberation time, the positive effect of a directional microphone may be diminished. The design of directional microphones makes them less sensitive at low frequencies than omnidirectional microphones. The greater the distance from the person (midpoint in figure 7.08), the weaker the input signal to the directional hearing aid microphone.

Directional microphones are used to optimise speech intelligibility in noisy environments. Unwanted sound from behind is attenuated, allowing the hearing aid user to focus on sound coming from the front.



▶ Figure 7.08. A person seen from above. The blue colour indicates the area within which a directional microphone picks up sound.

Microphone directionality can be achieved in two ways: with a dedicated directional microphone or with two identical microphones. A dedicated directional microphone has two sound inlets, one on either side of the diaphragm. An acoustic filter in the rear port delays the sound arriving from behind before it reaches the diaphragm. The pressure variation between the two incoming sound waves is picked up by the microphone diaphragm and transduced into an electrical output signal (fig. 7.09).

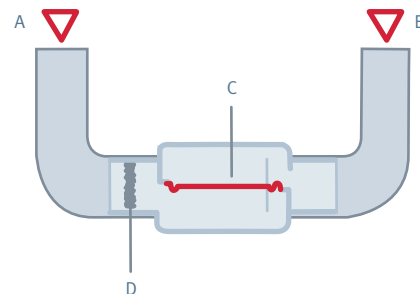

▶ Figure 7.09 Dedicated directional microphone with two sound inlet ports (A and B), one on either side of the diaphragm (C); this microphone measures the air pressure variation directly. The directional characteristics are implemented with a delaying acoustic filter (D).

Another way of achieving directionality is to use two identical microphones. In this setup, two microphones pick up sound and the directional effect is calculated by means of signal processing, using the delay between the sound input to the two microphones (fig. 7.10).

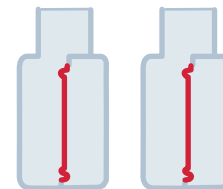

▶ Figure 7.10. Directionality can be achieved with two identical microphones. The directional effect is calculated by means of signal processing, using the signal delay between the sound input to the two microphones.

Telecoil for use with loop systems

Hearing aids may be equipped with a built-in telecoil, which is a small receiver that picks up signals from a loop system. A loop system consists of an amplifier and a loop. The loop system creates an electromagnetic field. Hearing aids with a telecoil can convert this electromagnetic field into a sound signal when the telecoil is activated. Only the signal from the loop system microphone is amplified, while acoustic background noise is shut out (fig. 7.11).

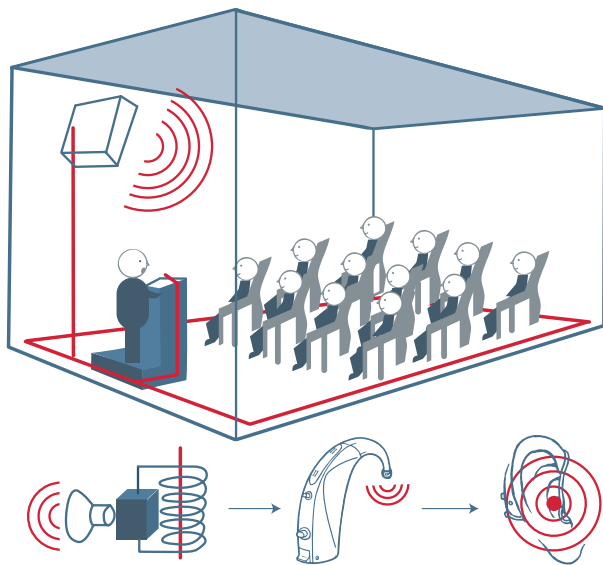

► Figure 7.11. A loop system generates a signal that can be heard in a hearing aid with a telecoil.

A telecoil converts the variations in the electromagnetic field into electrical signals. A switch on the hearing aid allows the user to choose the telecoil signal instead of the microphone signal.

The telecoil is used where a loop system is installed, for example in theatres, churches, in private homes for listening to the television or radio, and at schools for hearing impaired. When the telecoil function in a hearing aid is activated, sound sent through the loop system is amplified, while background noise is shut out.

Loop systems are often installed in theatres, cinemas and churches. Using the telecoil with a well functioning loop system can improve the sound quality considerably in situations with background noise and a relatively great distance to the sound source. Most hearing aids have a switch allowing the hearing aid user to choose whether to listen to the sound from the hearing aid microphone or from the telecoil. When the telecoil function is activated, the hearing aid microphone is switched off. Surrounding noise and reverberation are shut out and only signals from the loop system are heard. CIC hearing aids have no telecoil because of their small size. Note that in some hearing aids, the microphone and telecoil can be active simultaneously (MT setting).

Audio and FM input

An improved sound quality can be achieved by using a direct audio input on the hearing aid. This input enables direct connection to different kinds of assistive listening devices, such as a hand-held microphone or an FM receiver. This facility is often used in educational environments with wireless equipment.

Conversion from analogue to digital form

In order for the signal processor in a digital hearing aid to process an analogue signal and amplify it as required, it must first be converted from analogue into digital form. This is done in an analogue-to-digital converter (A/D converter).

The advantage of digital signal processing is that electrical components can be replaced by arithmetic calculations. A complex analogue circuit which requires many components is thus transformed into a number of computations.

Furthermore, problems with precision in analogue components caused by variation in temperature and voltage are replaced by the desired computational precision.

Simply put, digital technology is based on two states: Whether there is current in a wire (on) or no current (off). “on” corresponds to state 1, “off” corresponds to state 0. The two states represent a numeric system that is not based on the decimal system, that is from 0 to 9, but on the binary system using only the digits 0 and 1. By creating digital electronic circuits, it is possible to perform procedures, arithmetic operations, etc. with this system. The degree of complexity depends on the required functionality of the digital circuit.

When an electrical signal is converted to digital form by the A/D converter, the digitised signal is represented by the binary number system, i.e. 0 and 1. The analogue input signal is converted into a digital signal consisting of digits from the binary number system, expressing the size of the signal. We will discuss the digitising process in greater detail in the following sections.

Sampling frequency

The sampling frequency dictates at which time interval the analogue signal is converted into digital form. It is of particular importance for the reproduction of high frequency signals. The analogue signal is read at a fixed time interval which is set by the sampling frequency. The sampling frequency has to be at least twice as high as the highest signal frequency to be processed by the signal processor to achieve an adequate representation of the analogue signal (fig. 7.12).

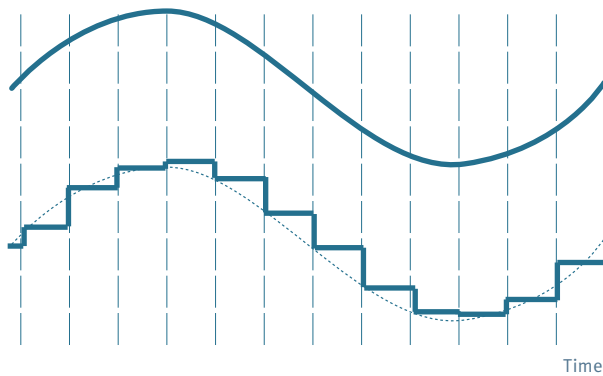

► Figure 7.12. A signal in analogue form (top) and the same signal in digitised form (bottom). Each step represents a numeric value. The signal is converted into a string of values that can be processed in the hearing aid's signal processor.

32 kHz, 44 kHz or 48 kHz sampling frequencies are usually used for different kinds of sound reproduction. CD's are recorded at a sampling frequency of 44 kHz. A Digital Audio Tape (DAT) recorder has a sampling frequency of 48 kHz.

Widex digital hearing aids use a sampling frequency of 32 kHz, which enables reproduction of signals with frequencies of up to 16 kHz. To reproduce signals of up to 20 kHz, the sampling frequency must be at least 40 kHz. In other hearing aids the sampling frequency may range between 16 and 32 kHz, which gives a poorer signal quality at frequencies of 8 kHz and higher. The better the signal quality is before processing, the better the final sound quality can be.

The importance of the bit number in the binary numeral

A digital signal can be represented as a binary numeral, that is a string of the digits 0 and 1. This bit stream is processed in the hearing aid's signal processor. The binary numeral is an indication of the magnitude or amplitude of the original signal, whereas the sampling frequency determines how often sampling takes place. Finally the processed bit stream is sent through a digital-to-analogue converter (D/A converter). The converter transforms the digital number into an analogue signal, which can be produced as output by the hearing aid receiver. To ensure a correct representation of the signal, it is sent through a low-pass filter.

The precision with which signal values are reproduced depends on the number of bits that make up the binary numeral. The greater the number of bits, the better the signal-to-noise ratio that can be achieved, and the better the signal quality.

The number of bits in the binary numeral indicates how many numeric values are available for the sampled value. All signal values converted in the A/D converter are rounded off to the nearest numeric values. A true signal value of, for example, 2093.3 is rounded off to 2093. The 0.3, which is not included, is called *quantisation noise*. A signal-to-noise ratio can therefore be calculated by comparing the largest signal that can be sampled with the amount of quantisation noise. Every single bit gives a 6 dB signal-to-noise ratio. In hearing aids 16-bit numerals are usually used to represent a digital signal. For comparison, a CD player also uses 16-bit numerals to reproduce sound.

Example of calculation of signal-to-noise ratio

If 16-bit numerals are used for sampling, the signal-to-noise ratio is $16 \times 6 \text{ dB} = 96 \text{ dB}$. When 20-bit numerals are used, the signal-to-noise ratio is $20 \times 6 \text{ dB} = 120 \text{ dB}$.

Robust bit flow

The bit flow is very robust. Each bit has a value of either 0 or 1. In a digital processor, these values will represent the minimum/maximum voltage available or current/no current states. As long as the processor is able to distinguish between these two states, the digitised stream will remain intact, without distortion or noise. Even a high amount of noise in the bit stream will not affect the information it contains.

A/D converter

Several types of A/D converters are available, but a Sigma-Delta converter is the type that is generally considered most suitable for sound signals. It uses a relatively high sampling frequency, typically 1 MHz, but only represents the signal using 1 bit per sampling cycle. Its function is quite complex. The principle, however, is that the individual bit is used to see whether the signal increases or decreases. Sigma and Delta are Greek letters used by mathematicians to symbolise summations (Sigma) and differences (Delta). The very rapid sequence of 1-bit numerals is converted into a bit stream of regular length for processing in the processor. Sigma-Delta converters work without external components and can be integrated entirely in an integrated circuit (IC).

Amplification and signal processing

The hearing aid hybrid amplifier contains most of the hearing aid's electronic components and circuits. The digitised signal is processed in the signal processor and amplified according to the hearing impaired individual's amplification needs and the hearing aid's settings. The amplified signal is fed to the hearing aid receiver and then received at the eardrum.

As all signal processing is done by computational operations, filtering and compression systems no longer need to be adjusted and controlled by means of external components. All computational operations are handled by the signal processor. This independence of external components gives added flexibility when carrying out different types of signal processing.

Still, there are many challenges associated with making a digital hearing aid work. A primary task is to make the digital circuits perform optimally with a hearing aid battery. Then there is the audiological challenge of creating a type of signal processing that exploits fully the advantages of digital technology. Digital hearing aids offer more advanced signal processing to hearing impaired persons than analogue technology.

In the hybrid amplifier/signal processor of a digital hearing aid, the signals from the A/D converter are processed and amplified according to the sound environment and hearing loss.

During amplification, the digital signal processing strategies described in the chapter "Signal processing" are applied.

An Integrated Circuit (IC), which is often no larger than a few square millimetres, can contain hundreds of thousands of resistors and transistors. Due to the small size of the IC, it has been possible to continuously reduce the size of hearing aids and make them more sophisticated. The IC used is often especially designed for one specific hearing aid model (fig. 7.13).



▶ Figure 7.13. The integrated circuit (IC) used in a Widex Senso CIC model is tiny.

Considerations for developing signal processors

Various approaches exist for the development of digital amplifiers. In the following paragraphs we want to introduce three main concepts:

- Use of an open platform generic Digital Signal Processor (DSP) and implementation of the functionality in programmable software saved in a memory block.
- Use of a specialised off-the-shelf DSP.
- Development of a dedicated DSP (Custom DSP) for a customised amplification and processing system, in which parameters can be changed and saved in a memory block.

Essential considerations in developing hearing aid processors are to minimise power and to use the limited space available optimally.

Open-platform generic DSP

An open-platform generic DSP is to a high extent software-controlled. The processor is designed to be programmable for different functionalities, much like a PC processor. An open-platform DSP solution can usually be developed within a shorter time frame than a dedicated DSP solution, but the fact that all processing is software-based typically adds to the total signal processing time. The advantage of the software-controlled DSP is added flexibility. Changes can be implemented more quickly than in a custom DSP. The disadvantage is the hardware overhead and increased power consumption or poorer performance for the same power consumption.

Specialised off-the-shelf DSP

As a result of the rapid development in signal processor technology, there are DSP platforms available that can be used in hearing aids. The use of off-the-shelf DSPs reduces the time required to develop the hardware for a new hearing aid. The time-consuming part is to program the hearing aid-specific software, whereas the processor's operating system, control loops and other processor operations are already thoroughly tested and available for use. The off-the-shelf DSP has limitations in framework and operating functionality. The size of the off-the-shelf DSP is fixed, and power consumption can only be reduced by lowering performance.

Custom DSP

A dedicated custom DSP is adapted to a specific purpose, while incorporating the required flexibility, so that specific power consumption and space requirements are optimised. A dedicated DSP allows more targeted optimisation of signal processing. Most of the functionalities are implemented in the IC itself and are hard-wired, which permits quicker processing than in a software-implemented solution. The IC parameters are also programmable within predefined limits. The development time for this implementation solution is typically longer than for a generic or off-the-shelf DSP. It is furthermore characterised by lower power consumption, but at the expense of reduced flexibility.

Amplifier types

Digital hearing aid amplifiers perform many more functions than analogue hearing aids. In the following sections, amplifiers should therefore be taken to mean a combined unit with converters, software memory and DSPs inclusive. This hybrid amplifier can be mounted onto a circuit board. Hybrid amplifiers can also be manufactured as thin-film or thick-film substrates, onto which discrete components and ICs are mounted.

Circuit board amplifier

The circuit board type amplifier is characterised by having discretely mounted components and is often larger in size than other types of amplifiers (fig. 7.14).

Previously this type of amplifier was used primarily in large hearing aids, such as body-worn hearing aids and large behind-the-ear models. Now, a refined version of the board exists (flexible circuit board). It can both serve as a circuit board and also for connecting hearing aid components.



▶ Figure 7.14. Hearing aid amplifier with discrete components.

Thin-film amplifier

The thin-film amplifier is constructed on a thin ceramic or glass board which has a surface layer of resistive material and gold. The manufacturing of thin-film amplifiers is a photographic process (fig. 7.15). By means of an etching process, discrete resistors are patterned in the resistive layer while the electrical connections of the circuit are patterned in the gold layer. Transistors, integrated circuits and condensers are glued onto the gold layer with electrically conductive glue. Transistors and integrated circuits are wire-bonded with thin gold wires.

Thin-film boards can only have a single layer of resistors and connections on either side. A single-sided thin-film board is mainly used as it is difficult to make connections between the two sides of a thin-film board.



▶ Figure 7.15. Thin-film amplifier for a hearing aid. It is manufactured using a photographic process.

Thick-film amplifier

A thick-film circuit consists of a thin ceramic substrate, on which resistors and electrical connections are mounted by means of a serigraphic process (fig. 7.16). The resistors and connections are larger than on the thin-film circuit, and adjustment of the resistors is necessary if a high degree of precision is required. There can be many layers on either side, and connections can be made between the layers and the two sides. The thick-film technique is the most used technique today. ICs, transistors and condensers are often mounted on both sides. The connections between the ICs and the circuit are often made as wire bonds or flip chips, where the ICs are turned face down and connected to the circuit by small conductive balls.

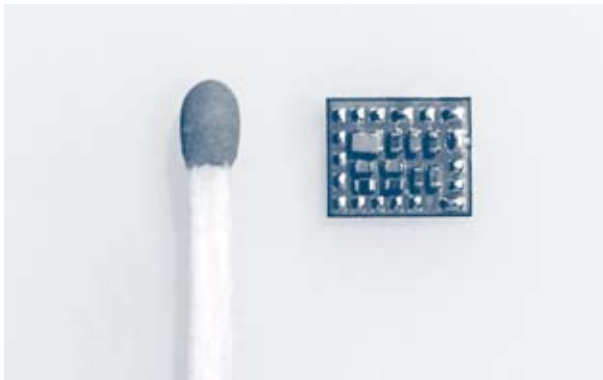

► Figure 7.16. Thick-film amplifier for a hearing aid. It is manufactured using a serigraphic process.

Electronic filters and their implementation

A filter is an electronic circuit that enhances or attenuates specific frequencies, thereby modifying the characteristics of the sound spectrum. The filters can be used to attenuate specified frequency components of the signal. The number and type of filters are hearing aid model dependent. There are hearing aids with 15 filters or more, others have only two or three filters.

The filter steepness, i.e. the filter slope, ranges from 6 dB per octave in a conventional, first-order passive filter to 12, 18 or more dB per octave in active filters using enhancing elements. In Figure 7.17 the filter slope is 6 dB per octave.

Low-cut filter

A very common type of hearing loss is presbycusis, which is a decline in hearing related to the normal ageing process. With this type of hearing loss low frequencies are audible and are not affected by presbycusis, while the hearing ability for high frequencies is reduced. As a result, people with presbycusis often have difficulty understanding speech in noisy environments. In these cases it is appropriate to attenuate the low frequencies in the sound spectrum with a low-cut filter before amplification. The low-cut filter is used to control gain for the low frequencies (fig. 7.17).

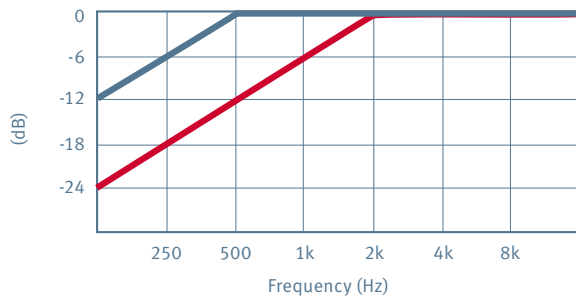

► Figure 7.17. A low-cut filter reduces gain for low frequencies. The lower curve attenuates frequencies of 2 kHz and lower, and the upper curve attenuates frequencies of 500 Hz and lower.

High-cut filter

The high-cut filter is used to reduce gain for high frequencies, usually above 1000 Hz. The high-cut filter is often used to give an appropriate amount of high frequency gain for a given hearing loss. It can also be used in powerful hearing aids to reduce the risk of acoustic feedback (whistling or feedback). The filter can also be useful in hearing aids for first-time users who initially have difficulty accepting high frequency gain, because it attenuates the high frequency gain that often causes annoyance. Once the users are accustomed to their hearing aids, the high-frequency gain can be gradually increased. High-cut filters can be designed with various cut-off frequencies (fig. 7.18).

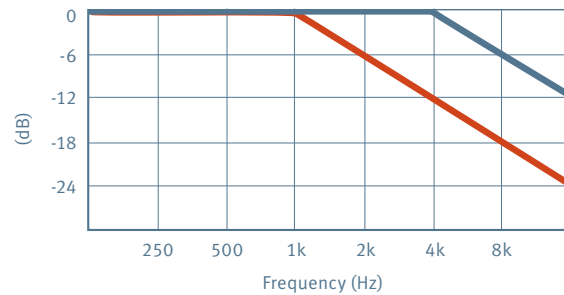

► Figure 7.18. A high-cut filter reduces gain for high frequencies. The lower curve attenuates frequencies of 1 kHz and higher, and the upper curve attenuates frequencies of 4 kHz and higher.

Division of the sound spectrum in multiple-band filters

Before entering the signal processor, the digital signal is divided into adjacent frequency bands. The number of bands depends on the hearing aid model in question. Some hearing aids have two bands, one for high and one for low frequencies. Other hearing aids may have multiple-band filters.

The division of signals into several bands enables the signal processor to manipulate the various parts of the signal in different frequency bands so as to reduce noise and improve speech intelligibility. The individual frequency bands are amplified according to the hearing loss configuration, and unwanted sound can be identified for separate bands and attenuated.

Implementation of filter bands

Division into frequency bands is achieved primarily by two methods (fig. 7.19):

- Discrete-time, electrically implemented filters
- Filters derived from a mathematical frequency transformation operation Fast Fourier Transformer (FFT).

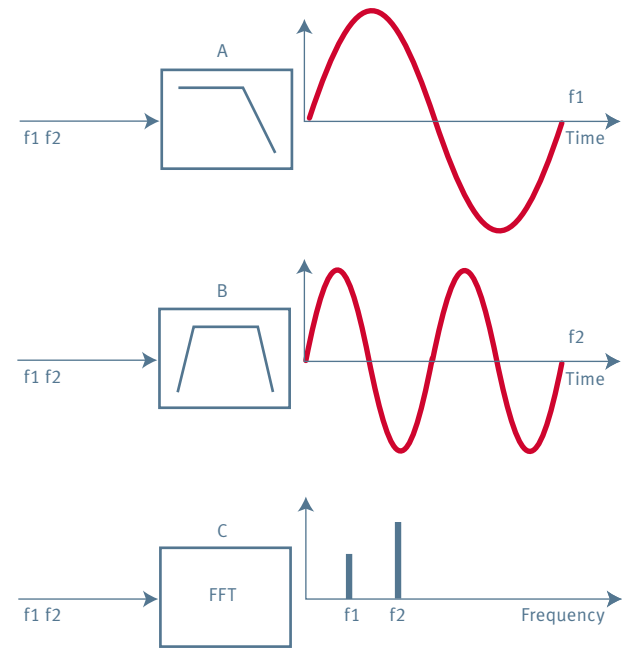

► Figure 7.19. Filter implementation options: A shows a high-cut filter which allows the low frequency f_1 to pass; B shows a band filter which allows f_2 to pass; C shows FFT implementation which maps the two frequencies on a frequency axis.

Discrete-time, electrically implemented filters offer the advantage of working with minimal delays of the sound signal and can be designed with the desired filter slope. The signal processing in the filter bands can be programmed according to the hearing loss configuration. A steep filter slope results in very little overlap with the adjacent frequency band. Steep filters enable effective filtering out of unwanted signals.

The filter bands can also be implemented using the FFT analysis. This method gives filters that overlap more, which makes it more difficult to filter out noise. On the other hand, this method is mathematical and can relatively easily be implemented in the software. FFT filters introduce a delay of the sound signal which may be uncomfortable and disturbing for the hearing aid user.

Discrete-time, electrically implemented filters usually have steep slopes and separate the filter bands more effectively than filters implemented using the FFT method.

The choice of filter implementation method is a delicate balance between power consumption at a constant signal delay, filter slope steepness and signal quality requirements.

Conversion from digital to analogue form

When the signal has been processed and amplified to the desired output level, it has to be converted into an analogue signal in order to be reproduced by the hearing aid receiver. This is done by a digital-to-analogue converter.

To minimise power consumption and have an integrated solution, digital hearing aids often use a digital-to-digital converter. The converter generates a high-speed serial output which is fed to the receiver, which accepts this type of input and is basically a part of the D/A converter. The receiver then produces a sound signal.

Receiver output

The receiver converts the amplified electrical signal into sound waves. A receiver works practically like a reversed microphone. The electrical signal from the hybrid amplifier sets the receiver diaphragm into motion, creating vibrations in the surrounding air. These vibrations can be picked up by the ear and heard as sound (fig. 7.20).

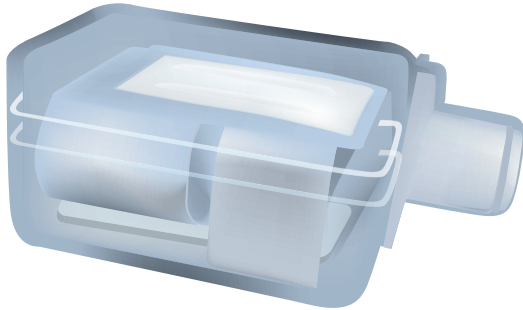

▶ Figure 7.20. Model of a hearing aid receiver. The amplified electrical signal enters the receiver and sets the diaphragm into motion, generating sound waves. In this figure the sound generated exits the receiver on the right side.

Receivers are available in different sizes and with different maximum output levels. The physical size of the receiver determines its maximum output level (fig. 7.21).

The maximum output level that can be generated by a receiver depends on its physical size. The smaller the receiver, the lower the output level. The smallest receivers are used in hearing aids for mild to moderate hearing loss. Large receivers are used in BTE and power aids, where a high amount of amplification and a high to very high output level are needed.

The smallest receivers are used in CIC hearing aids, because of the limited space available. These hearing aids are therefore only recommended for mild to moderate hearing losses. For the larger in-the-ear and behind-the-ear models like high power hearing aids a bigger receiver with a higher output level – up to 140 dB SPL – can be used.



▶ Figure 7.21. Hearing aid receivers placed on a ruler. The larger the receiver, the higher the maximum output level.

Hearing aid controls

The hearing care professional sets the basic fitting parameters when fitting the hearing aid. These settings can usually not be changed by the user. While some hearing aids are fully automatic, other hearing aids are provided with manual controls, like a volume control or a switch for selecting listening programs.

Volume control

Some BTE and ITE hearing aids can have a volume control, which allows the hearing aid user to change the volume according to different listening situations. Others, such as CIC hearing aids have no manual controls. They are programmed for fully automatic operation during the fitting process.

On/off switch

Some hearing aids have an on/off switch. The switch may be mounted on the hearing aid or be an integral part of the battery drawer.

Telecoil switch

Many hearing aid models have a switch that gives the user access to receive signals either from the hearing aid microphone or a loop system. This is called an M-T switch. Activating the T setting switches off the microphone, and only signals transmitted from the loop system are audible.

In some situations it can be useful to receive signals both via the telecoil and the microphone, for example if the user wants to listen to the TV and still hear surrounding sounds, such as speech or the doorbell. Many hearing aids therefore also have an MT setting in which both the microphone (M) and telecoil (T) are active.

Listening program button

Hearing aids may have several listening programs, each optimised towards a specific listening situation. An example of this is a music program. The listening program button or switch can be located on the hearing aid itself or the program selection function can be incorporated into a remote control.

Remote control

Some hearing aid users want to control their hearing aids in a more sophisticated and discreet way. They wish to have a number of options to choose from in various listening situations. As many hearing aid users want their hearing aids to be small and cosmetically acceptable, there is no space for manual controls on the hearing aid itself. These functions can then be handled by a remote control.

With the remote control the user can choose from a number of preset programs for different listening situations. The communication between the remote control and the hearing aid can be handled by either infrared light, ultrasound or radio waves.

Hearing aid batteries

Modern hearing aids can place heavy demands on their batteries in terms of operating voltage and lifetime. The most commonly used type of hearing aid battery is the zinc air battery, which comes in various sizes. There are standard and high power batteries. The latter are used for power hearing aids because they can provide the required high output level.

Hearing aid batteries should be chosen with great care to match the specific hearing aid, amplification requirements and hearing aid usage pattern. It is recommended to use a battery type that combines the long lifetime of standard batteries with the high performance of high power batteries.

Performance through high and stable operating voltage

Modern hearing aids require an operating voltage of approx. 1.1 volts. Zinc air type batteries have a nominal voltage of 1.4 volts. This voltage is only present when the battery is not drawn on. When the hearing aid is in use, the effective operating voltage lies typically between 1.15 and 1.35 volts. The big difference in operating voltage demonstrates that batteries from different manufacturers are not alike. Another factor that influences operating voltage is temperature, which affects both zinc air and other types of batteries.

A high and stable voltage ensures the best working conditions for the hearing aid and that the necessary gain requirements can be met by the hearing aid. If the battery operating voltage is below 1.1 V, both gain and output can be reduced. The greatest drawback of a low battery operating voltage is that it increases the risk of hearing aid malfunction. One of the symptoms can be false battery alarms in critical situations, for example, when the hearing aid has to produce high sound pressure levels and/or the hearing aid is operated at very low ambient temperatures.

The only drawback of a high operating voltage is that the hearing aid's power consumption is high. It may seem paradoxical that a really good battery has a shorter lifetime than a lower quality battery, even though they have exactly the same capacity. Increased dynamics and a high sound pressure level in the hearing aid reduce battery lifetime, typically in the order of 5 to 10%.

Usage pattern and battery lifetime

The hearing aid user should always turn off the hearing aid when it is not in use. If the hearing aid will not be used for some days or weeks, the battery should be removed from the battery drawer. An activated battery may leak electrolyte substance and/or swell up, which can lead to damage in the hearing aid.

The choice of batteries also depends on the conditions under which they are used. The lifetime of activated zinc-air batteries varies a great deal even when the hearing aid is not in use. The lifetime of an activated zinc-air battery is approximately five to six weeks. If the hearing aid is only used for a couple of hours a day, the original battery capacity will not be used efficiently. A battery lifetime of approximately fourteen days usually means that between 90% and 98% of the original capacity is used. If the hearing aid is only used for a short period of time every day, extending the battery lifetime to approximately four weeks, the usable effective capacity typically falls to approximately between 40% and 85%, depending on the battery brand.

Battery capacity is measured in milli Ampere hours, abbreviated as mAh. A battery with a capacity of 150 mAh can supply 1 mA for 150 hours, 2 mA for 75 hours, etc.

An important factor in optimising battery lifetime is correct storage. Zinc-air batteries should be stored in a cool place, but not in a refrigerator. The best storage conditions are a temperature of approximately 17 to 22 degrees and a relative air humidity of between 40% and 60%. Batteries should be kept in their original packing until use to protect the air-tight sealing. If air enters a zinc-air battery, it will be activated and begin to discharge. Another advantage of keeping the batteries in their original packing is that it allows the user to keep an eye on the expiry date, which is usually printed on the packing in an abbreviated form.

Other battery types

There are other battery types besides the zinc-air type, including the silver oxide battery, which does not have the same lifetime constraints. The operating voltage of a silver-oxide battery is higher than in a zinc-air battery, (approximately 1.5 volts), but it only has a capacity of approximately 30% compared to a zinc-air battery. As silver oxide batteries are more expensive, they are rarely the best choice for hearing aids. The mercury batteries used previously have a relatively low capacity and poorer voltage conditions. Mercury batteries are no longer used, due to more stringent environmental requirements.

The most powerful hearing aids, body-worn aids, use type AA or AAA alkaline batteries. These batteries, as well as the small flat lithium batteries, are used in remote controls for hearing aids.

The most widely used battery types for hearing aids and accessories are described in the table below.

BATTERY TYPE	IEC DESIGNATION	DIMENSIONS mm	NOMINAL VOLTAGE v	CAPACITY mAh	APPLICATION
5	PR 521	5.9 x 2.1	1.4	35	CIC
10	PR 70/PR 536	5.9 x 3.6	1.4	80	CIC, ITC
312	PR 41	7.9 x 3.6	1.4	150	ITC, ITE
13	PR 48	7.9 x 5.4	1.4	250	ITE, BTE
675	PR 44	11.6 x 5.4	1.4	600	BTE
AAA	LR 6	10.5 x 44.5	1.5	1100	remote control body-worn aids
AA	LR 03	14.5 x 50.5	1.5	2600	remote control body-worn aids
2032	CR 2032	20 x 3.2	3	200	remote control

A series of seven thin, light gray wavy lines that flow from the left side of the page towards the right, creating a sense of motion and depth. The lines are layered, with some appearing in front of others, and they all converge towards the right edge.

[CHAPTER 8]
SIGNAL PROCESSING



CHAPTER 8

SIGNAL PROCESSING 164

Main signal processing objectives 164

Audibility of sound 164

Difficult listening situations 166

Comfort 166

SIGNAL PROCESSING IN LINEAR HEARING AIDS 167

Input/output function 167

Frequency characteristic 169

Output characteristic at saturation level 169

SIMPLE COMPRESSION HEARING AIDS 170

Input/output function 170

Attack and release times 171

Output limiting at high input levels 174

Wide Dynamic Range Compression 176

COMPRESSION IN MODERN HEARING AIDS 177

Multichannel compression 177

Multi-segment compression 178

Variation of attack and release times 179

Effect of attack and release times on input/output 180

SPECIAL SIGNAL PROCESSING STRATEGIES 181

Directional microphones 182

Fixed directional system 182

Dual-microphone directional system 183

Directional characteristics 183

Directivity Index 184

Adaptive directional microphone 185

Adaptive microphone matching 186

Noise classification in an adaptive directional system 186

Noise reduction 187

When can noise reduction be beneficial? 187

How does the hearing aid distinguish between speech and noise? 187

Noise reduction in a digital hearing aid 188

Positive effect of noise reduction 189

Feedback reduction 189

Causes of acoustic feedback 189

Feedback control through signal processing 190

Feedback reduction by limiting gain 190

Active feedback suppression 191

Feedback test 192

OTHER SIGNAL PROCESSING APPLICATIONS 193

Self-test of the hearing aid's electronic parts 193

Increased comfort with reduced occlusion 193

Listening programs 193

SIGNAL PROCESSING

In a digital hearing aid the continuous signal from the microphone system is digitised in a sampling process where the analogue signal is converted into a discrete digital signal. Following this step, a variety of functions can be introduced in the signal path to process the sound and thus optimise the output of the hearing aid.

Main signal processing objectives

In processing signals, a number of objectives are maintained. These include:

- Audibility of sound
- Speech intelligibility in difficult listening situations
- Comfort

Audibility of sound

The main objective of a hearing aid is to render audible the sounds which otherwise, due to hearing loss, have become fully or partially inaudible. This includes speech but also other sounds. However, there is no need to overamplify trivial sounds that would only disturb and inconvenience the hearing aid user.

The need to make all components of speech audible is illustrated in figure 8.01. The dark shaded areas in the left illustration indicate the speech signal components at normal voice level at a distance of one metre from the speaker. The illustration also depicts the audible range of an individual with a typical sensorineural hearing loss. As can be seen, the only overlap between the audible range and the speech spectrum is in the low-frequency region.

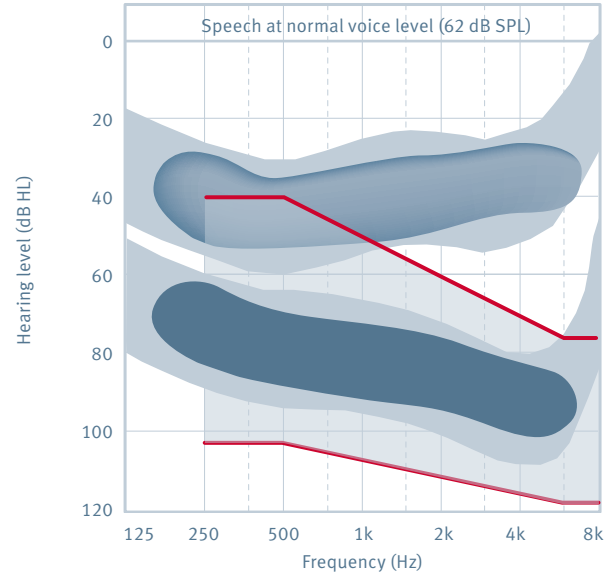
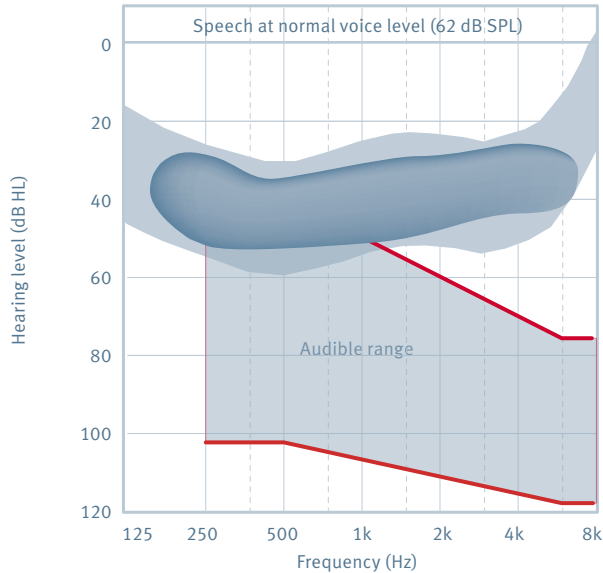

► Figure 8.01. The audible range of an individual with a typical sensorineural hearing loss and the speech spectrum measured in critical bands (dark shaded areas). With a hearing aid, the speech spectrum is amplified and lies in the audible range. See figure to the right.

Speech and other complex signals contain both low- and high-frequency components. In the left illustration in figure 8.01, only the low-frequency components of the speech signal lie within the audible range of the individual in question. The high-frequency sounds lie outside the residual dynamic range and are inaudible. This listener would hear that someone is talking, but may have difficulty understanding what is being said – especially in noisy environments.

One of the challenges of the signal processing in the hearing aid is to shape the speech signal so as it lies within the dynamic range of the hearing aid user, i.e. above the hearing threshold, but below the threshold of discomfort. To achieve this, soft sounds must be amplified more than loud sounds, and the highest amount of amplification must be provided in the frequency regions where the loss of hearing sensitivity is greatest.

Signal processing helps ensure that low- and high-frequency speech components are amplified to provide a balanced sound picture within the hearing aid user's dynamic range. The right illustration in figure 8.01 shows the result of such signal processing.

Difficult listening situations

Most people with hearing loss have problems understanding speech in difficult listening situations, for example in places with excessive background noise or places with long reverberation times. Listening to the television can also be problematic, as the speech signal is often mixed with music and sound effects and can vary greatly in volume. These are situations in which most users want their hearing aids to help them. As mentioned earlier, it is not convenient to provide the same amount of amplification for all sounds. The aim is to optimise the overall sound quality by enhancing the frequency regions that are important for speech intelligibility and reducing background noise.

There are a number of different ways to address this challenge. One way is to use directional microphones, which can be controlled on the basis of the current listening situation to provide greater attenuation of signals arriving from behind and the sides than of those coming from in front of the listener. Another method is noise reduction that separates speech from noise in the incoming signal and only enhances speech. By means of digital technology these methods can work very effectively and can be designed to only be active when required.

Comfort

In our everyday lives we are constantly exposed to loud sounds such as traffic noise, the clinking of china and cutlery, and banging doors. Due to the amplification provided by a hearing aid, the user may perceive such sounds as being uncomfortably loud. It is therefore important that the hearing aid does not amplify loud sounds unnecessarily. This is achieved by reducing the hearing aid gain in sound environments with a high sound pressure level and by ensuring that the hearing aid cannot produce sound at levels above the user's comfortable listening range.

Hearing aids are commonly worn with earmoulds or shells that block or partially block the ear canal. This blockage may cause the user to perceive their own voice and chewing sounds as being unnaturally loud. This is called the occlusion effect. Also feedback whistling that occurs when sound from the hearing aid receiver leaks back to the microphone can be annoying for the user. It is essential that the signal processing in the hearing aid minimises these causes of discomfort so as the wearer may enjoy their listening experience.

SIGNAL PROCESSING IN LINEAR HEARING AIDS

If a hearing aid is 'linear', the same amplification is provided for all input levels until the maximum output is reached. The sound pressure level of soft speech is typically 55 dB SPL, whereas the level of loud speech is 70 dB SPL. A linear instrument will preserve this relationship and amplify soft and loud speech to the same extent, in this case with a level difference of 15 dB.

When the sounds to be amplified are loud, the hearing aid amplifier may be driven into saturation. This means that the hearing aid's maximum output has been reached and an increase in input signal no longer produces additional output.

Signal processing in conventional linear hearing aids can be achieved with both analogue and digital technology. There are two main fine tuning controls:

- Tone adjustment for setting the frequency balance between low-pitch and high-pitch tones
- Maximum power output (MPO) control for adjusting the maximum output of the hearing aid (saturation level)

As linear hearing aids provide the same amount of amplification for low-level and high-level sounds, it may be necessary to adjust amplification when the input signal is particularly soft or loud. The volume control on a linear hearing aid allows the hearing aid user to adjust the volume according to their current listening environment.

The response of a linear hearing aid at different input levels and frequencies can be described by three main graphical displays:

- Input/output (I/O) function
- Frequency characteristic
- Output characteristic at saturation level

Input/output function

The I/O function is a curve that plots a hearing aid's output levels as a function of input levels at a given frequency. The x-axis of the I/O curve shows the sound level of input signals, and the y-axis shows the sound level of the amplified signal.

Figure 8.02 shows an I/O curve for a linear hearing aid providing 50 dB of amplification and with a maximum output level of 120 dB SPL. In this setting, the hearing aid is linear for input levels up to 70 dB SPL.

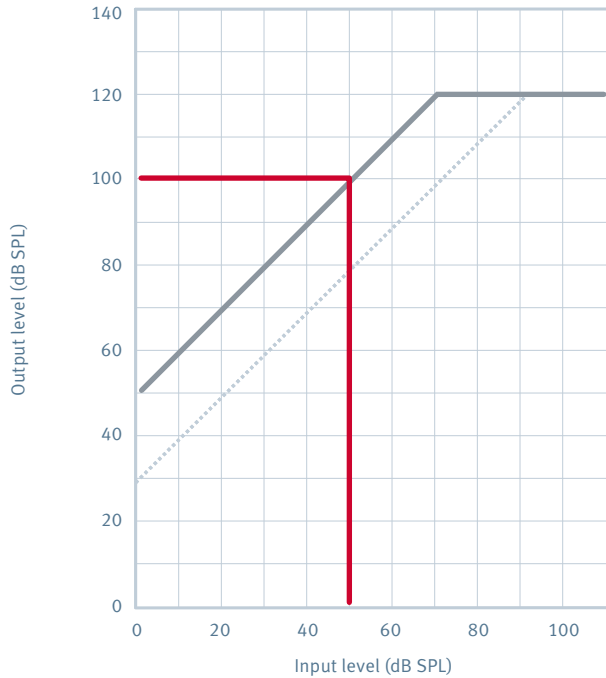

For input levels below 70 dB SPL, the gain from the hearing aid is 50 dB. At input levels higher than 70 dB, the output is limited so it does not exceed 120 dB SPL.

It is characteristic for a linear hearing aid that an increase in input results in a corresponding increase in output. This can be seen in figure 8.02 where an input of 50 dB gives an output of 100 dB, and an input of 60 dB gives an output of 110 dB. If the gain of the hearing aid is lowered to 30 dB, the linear range is expanded to 90 dB SPL input.

► Figure 8.02. Input/output curve for a linear hearing aid with 50 dB gain. With an input level of 50 dB SPL, the output level is 100 dB SPL. For all input levels of 70 dB SPL or higher, the hearing aid provides the maximum output level of 120 dB SPL. The dotted curve shows the input/output curve of a hearing aid with 30 dB gain.

Frequency characteristic

Figure 8.03 shows the frequency characteristic of a linear hearing aid. The frequency response curve is measured in an ear simulator, and shows the difference in dB between the hearing aid output measured in the coupler and the input level measured at the hearing aid microphone. It can be seen that with an input level of 60 dB SPL at all frequencies, the output at 1000 Hz is 50 dB higher.

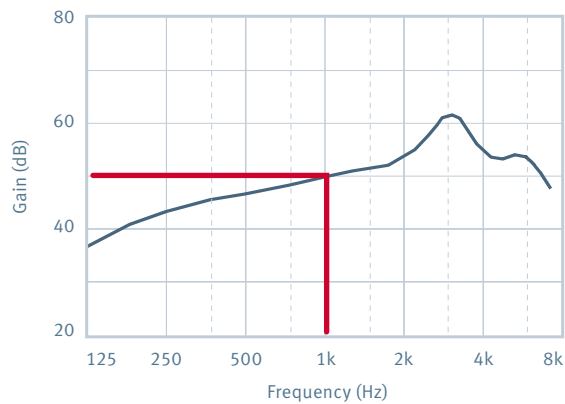

► Figure 8.03. Frequency/gain curve of a linear hearing aid showing the gain at a specific input level for all frequencies.

It can also be noted that a linear hearing aid does not necessarily amplify all frequencies to the same extent.

Output characteristic at saturation level

The output characteristic at saturation level is a curve that shows how many dB SPL the hearing aid can produce in a coupler when the input level is so high that it drives the hearing aid into saturation. The curve in figure 8.04 shows that at an input level of 90 dB SPL, at all frequencies, the output at 1000 Hz is 120 dB SPL.

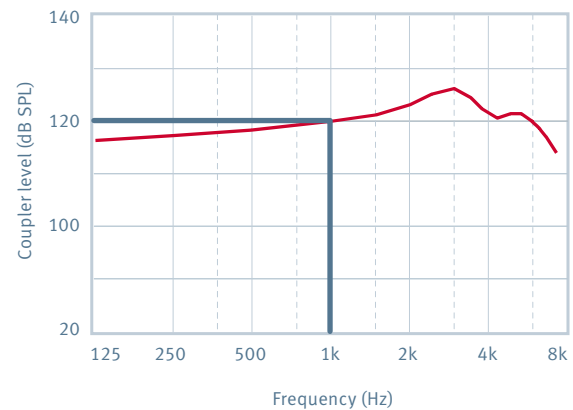

► Figure 8.04. Output characteristic at input levels at or above those that result in the maximum output levels for a linear hearing aid.

SIMPLE COMPRESSION HEARING AIDS

A drawback of linear hearing aids is that the user constantly has to adjust the volume manually. To be able to reproduce the soft and loud sounds of an everyday sound picture within the user's dynamic range, the hearing aid's compression must ensure appropriate amplification relative to input sound pressure levels. Compression automatically adjusts gain so that more gain is provided for soft sounds than for loud sounds. This is called Automatic Gain Control (AGC).

Compression hearing aids are also referred to as non-linear instruments.

Input/output function

The signal processing of the compressor can be characterised by the following parameters:

- Compression threshold
- Compression ratio
- Attack and release times

The input/output function for a simple nonlinear hearing aid is shown in figure 8.05. For input levels below 40 dB (segment A), the hearing aid provides linear gain of 50 dB. At input levels above 40 dB (segment B), the compression circuitry in the hearing aid is activated. This point at 40 dB is therefore called the compression threshold (CT). When the input level exceeds 80 dB (segment C), the output level does not increase further, but remains constant at 110 dB SPL.

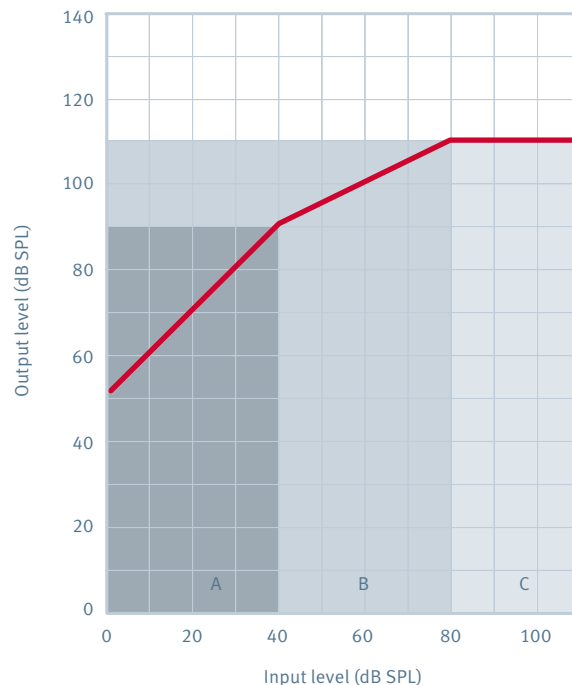

► Figure 8.05. Input/output curve for a compression hearing aid.

Segment B is a compression segment. This can be seen because an increase of the input level produces a smaller increase in the output. For example, if the input level is increased by 10 dB, the output increases by 5 dB. The ratio between the increase in input to the increase in output is called the compression ratio (CR). In this example, the CR is $= 10:5 = 2:1$. The point on the I/O curve at which the slope changes is called the knee-point. The characteristic shown in figure 8.05 has a knee-point at an input level of 40 dB.

The compressor function can also be illustrated by an input/gain curve. The input/gain curve provides the same information as the input/output curve, but specifies the gain the hearing aid provides at different input levels (fig. 8.06).

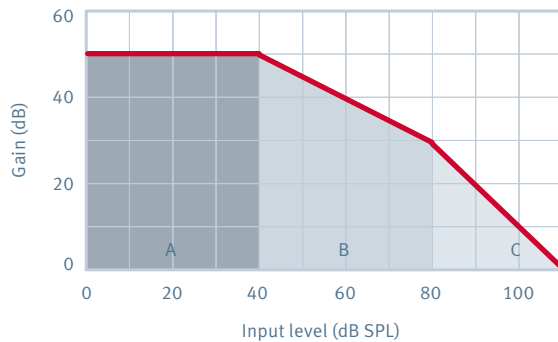

► Figure 8.06. The input/gain curve for the same compression hearing aid as in figure 8.05. At input levels of up to 40 dB (A), the gain remains 50 dB. For input levels between 40 and 80 dB SPL (B), the gain is reduced. From 80 to 100 dB SPL (C), the input level is only amplified up to the maximum output of the hearing aid.

Attack and release times

As mentioned earlier, a compression hearing aid changes its gain automatically in response to a change in input level. If the gain is changed too suddenly, the acoustic waveform will be distorted – resulting in audible distortion. This problem is counteracted by allowing some time to lapse before the compression is fully active or deactivated again.

The time that lapses from an increase of the input level until the output level is within ± 2 dB of the steady-state value is called the attack time. The time that lapses from a decrease of the input level until the output level is within ± 2 dB of the steady-state value is called the release time or recovery time.

The speed with which compression instruments adjust gain varies a great deal. This is especially the case for digital instruments where the regulation speed may be influenced by the signal characteristics. The classic way of characterising the regulation speed of a compressor is by stating attack and release times in milliseconds (ms).

Figure 8.07 shows how the output level is adjusted to a steady-state value after an increase in the input level.

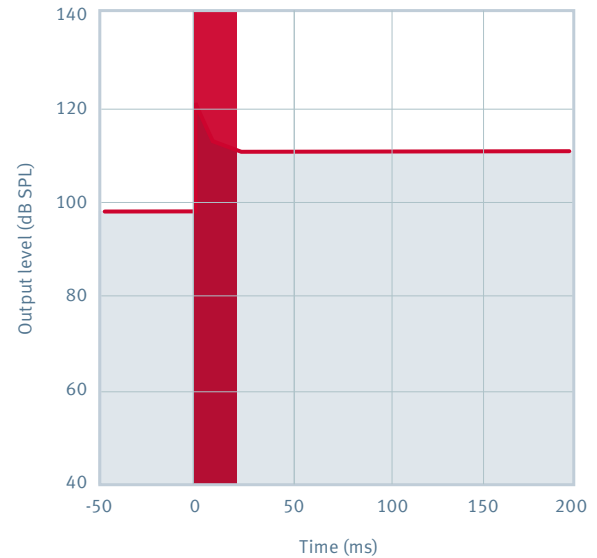
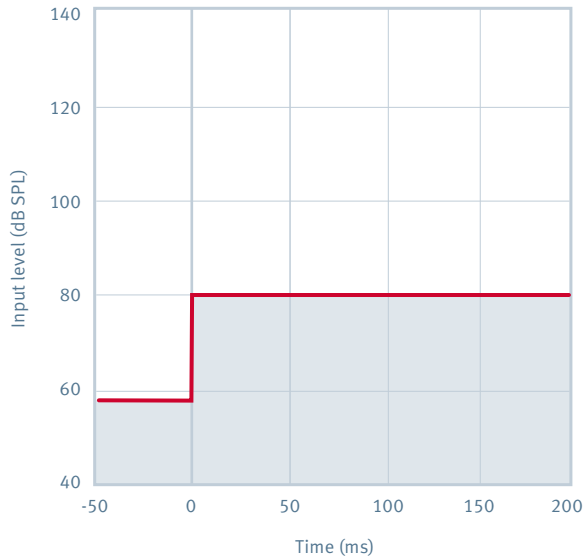

► Figure 8.07. When the input level (left) suddenly increases at 0 ms, the output level (right) will first increase by the same dB value. Due to the compression, the output rapidly decreases. The red shaded region is the attack time.

Compression is therefore not activated immediately. The time that lapses from the increase of the input level until the output level is within ± 2 dB of the steady-state value is called the attack time. The attack time for a hearing aid is typically between 0 and 25 ms.

Figure 8.08 illustrates how the level is adjusted to the steady-state value following a sudden decrease in the input level.

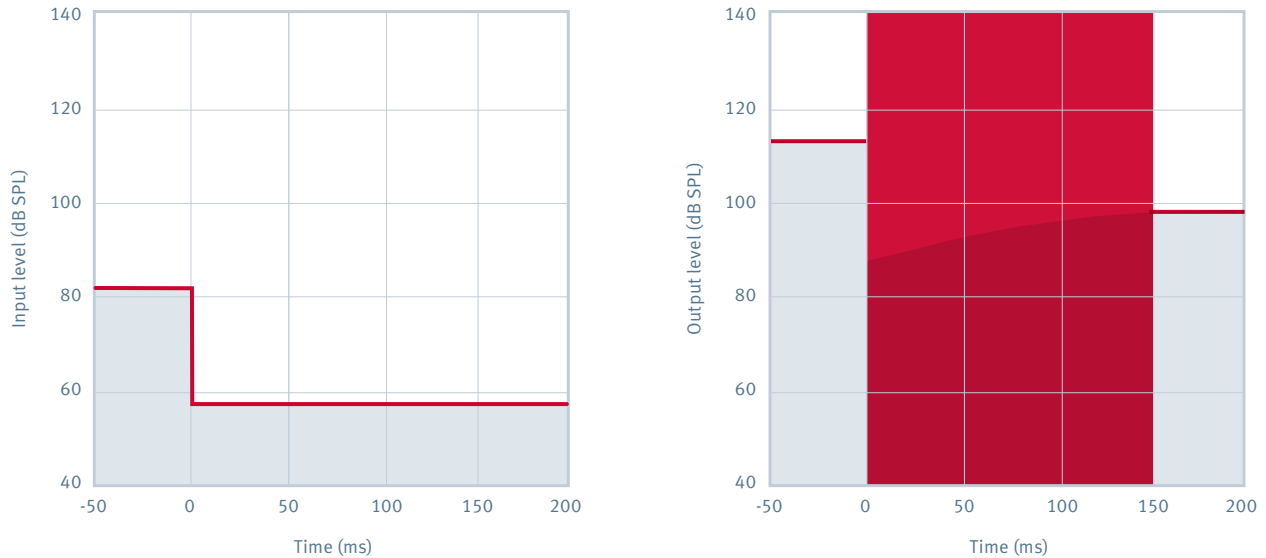

► Figure 8.08. When the input level suddenly decreases (left), the output will first decrease by the same dB value, but due to the compression the output rapidly increases (right). The red shaded region is the release time.

The time that lapses from the decrease of the input level until the output level is within ± 2 dB of the steady-state value is called the release time. The release time for a hearing aid is typically between 25 ms and 10 s. This is because many hearing aid users perceive an increase in background noise when shorter release times are used.

A hearing aid with just one compressor is called a one-channel instrument. A one-channel hearing aid will reduce its gain when the input level exceeds the compression threshold in any area of the frequency spectrum.

This may not allow enough flexibility to adjust sound satisfactorily in all situations.

An example is when a loud low-frequency sound activates the compressor and reduces gain so that high-frequency sounds at a moderate level are no longer audible. Gain regulation in just one channel may also be inadequate when the hearing loss varies across frequencies. It is therefore an advantage if the hearing aid has multiple compression channels.

Output limiting at high input levels

As gain in linear hearing aids is not reduced at high input levels, it is especially important to limit maximum output in these hearing aids.

In earlier hearing aids, the maximum output was adjusted by peak clipping (PC), a process of momentarily limiting the maximum output of a hearing aid. As PC creates audible distortion that can be bothersome to some users, output limiting became the preferred method. Output limiting is implemented by means of a compressor, called automatic output control (AOC). Figure 8.09 shows a comparison of the two output-limiting techniques (PC and AOC) with corresponding input/output curves.

Maximum output can be limited by peak clipping, which creates distortion, or by automatic output control, which can preserve the acoustic waveform without creating distortion.

Figure 8.09 shows a pure tone as the input signal of a linear hearing aid. If the tone is relatively loud, and if output limiting were not used in the hearing aid, the amplified signal would look as shown in figure 8.09 (B). This signal level will typically be too loud for the hearing aid user, as the linear hearing aid does not automatically reduce gain for high input levels. Figure 8.09 (C) shows how the signal is limited by peak clipping.

In modern linear hearing aids, the output-limiting function is instead handled by the automatic output control (AOC). This is illustrated in (D), where the signal is limited using a very high compression ratio. When a compressor is used to limit the output, the waveform is preserved intact and distortion minimised.

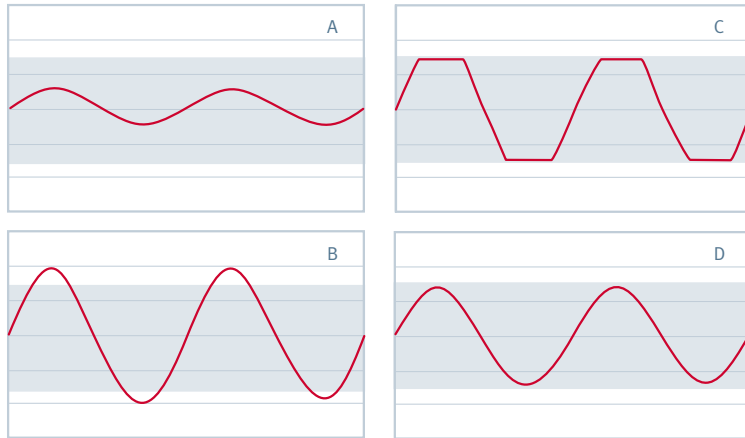

► Figure 8.09. Output limiting when output reaches the maximum permissible output of the hearing aid (grey area). Output can be limited by peak clipping or automatic output control. (A) shows a pure tone input, (B) shows the amplified signal. (C) shows the output signal with peak clipping, and (D) the output signal with AOC.

Wide Dynamic Range Compression

When compression is active over a large input range, it is called Wide Dynamic Range Compression (WDRC). The focus of WDRC is to adjust gain so that the output levels of the hearing aid match the hearing aid user's loudness growth within their entire dynamic range, from the threshold of audibility to the UCL.

With WDRC, the amplified signal is compressed to restore normal loudness growth for the hearing aid user.

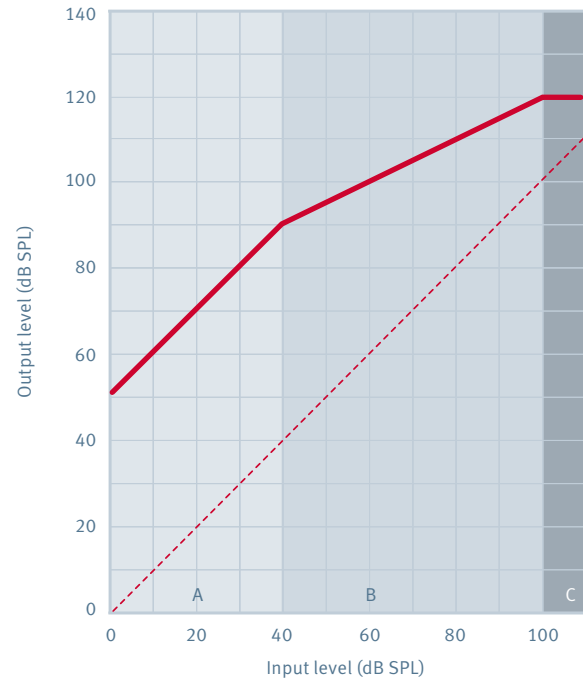

► Figure 8.10. Input/output response of a wide dynamic range compressor. Input is amplified according to the input level, which can be low, mid or high. The compression ratio is 1:1 in the A range, 2:1 in B, and in C the hearing aid produces maximum output.

The input/output curve for a WDRC compressor is shown in figure 8.10. Low input levels of up to 40 dB SPL are amplified linearly, input levels of between 40 and 100 dB SPL are compressed at the ratio of 2:1. For high input levels of more than 100 dB SPL, the hearing aid produces its maximum output of 120 dB SPL.

COMPRESSION IN MODERN HEARING AIDS

Modern hearing aids exclusively use digital technology, which enables sophisticated functions that are not available with analogue technology. Compression is an important aspect of signal processing in modern digital hearing aids. It is more complex than the simple compression techniques involved in PC or output limiting. Compression can be frequency dependent. This is beneficial as the dynamic range of hearing is not the same for all frequencies. The compression ratio (CR) can be made level-dependent, which is useful because studies show that users do not appreciate the same compression ratio for all sound levels. The attack and release times can also be made dependent on the sound signal characteristics. Studies indicate that hearing aid users prefer slow regulation in some situations and faster regulation in others.

Compression in modern hearing aids depends on the frequency and level of sound, as well as on sound signal characteristics. The frequency of sound is important for compensating for the individual ear's hearing loss. The sound level determines what the compression ratio should be in order to restore normal loudness growth. The sound signal characteristics determine which attack and release times produce optimum sound quality.

Multichannel compression

It may be an advantage to use frequency-dependent compression. As hearing loss is rarely completely flat over the entire frequency range, the dynamic range will often vary according to frequency. If sound over the entire frequency range is to be reproduced within the user's dynamic range, the compression ratio must be frequency-dependent.

Another reason for using frequency-dependent compression is that the frequency composition of speech varies. Therefore, having just one compressor for the whole frequency range is not optimal.

A typical compression instrument will have several compressors working, each in their own frequency region. Generally two or three compressors are enough to reproduce everyday sounds in a satisfactory way for most hearing aid users. Some hearing aids use more channels. This can be advantageous provided that precautions are taken not to equalise the spectral differences of the sound, as this can reduce speech intelligibility.

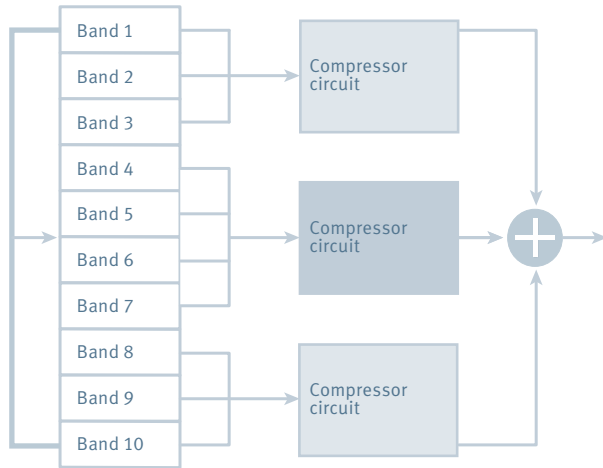

► Figure 8.11. A multichannel hearing aid, in which sound is divided into 10 frequency bands by means of a filter bank. This allows adjustment of the level of the individual band to achieve the desired frequency balance. The frequency bands are combined and processed in three independently controlled compressor circuits, where dynamic processing takes place.

A hearing aid designed as in figure 8.11 can be characterised as an instrument with 10 bands and 3 channels. It is the number of compressors that defines the number of channels. In order to fully describe a multichannel compression system, it is necessary to specify a curve for each compressor and its frequency range.

An alternative to using a filter bank is to separate the signal into frequency bands by Fast Fourier Transformation (FFT). This technique is a mathematical operation and typically results in long signal processing delays, particularly if the cut-off for low frequencies is to correspond to that of the ear.

Multi-segment compression

The functions of signal processing in the individual channels are multiple, as the same compressor performs different degrees of compression. At high input levels, the sound must be compressed in such a way that loud sound is not perceived as being uncomfortable. At low input levels, soft sounds must be amplified to make them audible.

With the introduction of digital technology it became possible to use highly advanced compressor types. These are capable of allowing complex compression characteristics, where the compression ratio is varied according to the input level. This is called multi-segment compression (fig. 8.12).

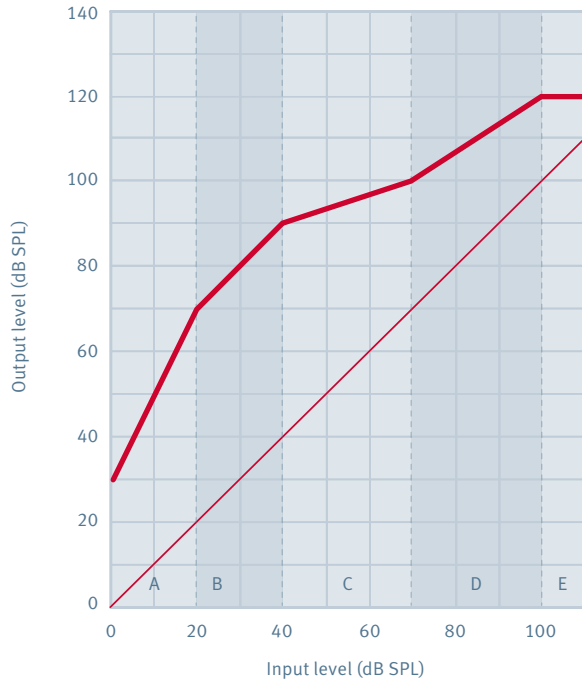

► Figure 8.12. Compression characteristic with several segments: A, B, C, D and E. In the C and D segments, the input is compressed at a ratio of 3:1 and 1.5:1 respectively. E is an output-limiting segment. The B input range features linear amplification, and A is an expansion segment.

Variation of attack and release times

With an increase of segments in the input/output characteristic, it is also possible to refine the compressor's attack and release characteristics. This can be useful because a large variation in gain is not appropriate for all situations. For instance, when listening to speech in low-level background noise, fast variations in gain will be disturbing. In other situations, fast-acting regulation of gain may be desirable. With a sudden loud sound or a sudden change in background noise fast variations in gain will add to the listener's comfort. With digital technology it is possible to control variations in gain adjustments.

Nonlinear hearing aids use combinations of fixed or situation-dependent attack and release times. The input/output curves for modulated input signals, such as speech, will always differ from the static input/output function.

In some hearing aids, the regulation is faster in some frequency regions than in others. In other aids, the regulation speed depends on the specific listening situation and input signal. Here gain may be allowed to change rapidly in response to a change in the user's listening situation, for example from a noisy environment to a quiet environment, while only changing slowly in consistent listening situations.

Another example is the regulation of gain for an impulse sound, such as the slamming of a door. In this case, very fast activation is desirable to avoid discomfort. However, when the transient sound has gone, the hearing aid should return to the normal state.

A compressor is often characterised by its attack and release times. Very fast-acting compression is called instantaneous compression, while compression with short time constants of around 100 ms is called syllabic compression. The designation of 'syllabic' refers to the fact that gain can be regulated over the time one syllable lasts.

Slow-acting compression is when attack and release times exceed one second. Slow-acting compression is often preferred in moderate background noise, while instantaneous, or syllabic compression is well suited to very quiet environments. The combination of fast-acting and slow-acting compression is sometimes called *dual compression*.

Effect of attack and release times on input/output

Input-dependent amplification in nonlinear hearing aids is often represented as a stationary input/output characteristic. These characteristics are based on standardised measurements that use a continuous sine tone at a specified frequency as input. The level of the tone is increased gradually, and the hearing aid output is measured after the compressor has stabilised to the new input level. However, static input/output and input/gain characteristics do not show how a hearing aid compressor behaves in response to complex inputs, such as a modulated speech signal. In this case, the actual amount of amplification will depend on the dynamic variations of the input signal, as well as the attack and release times of the hearing aid.

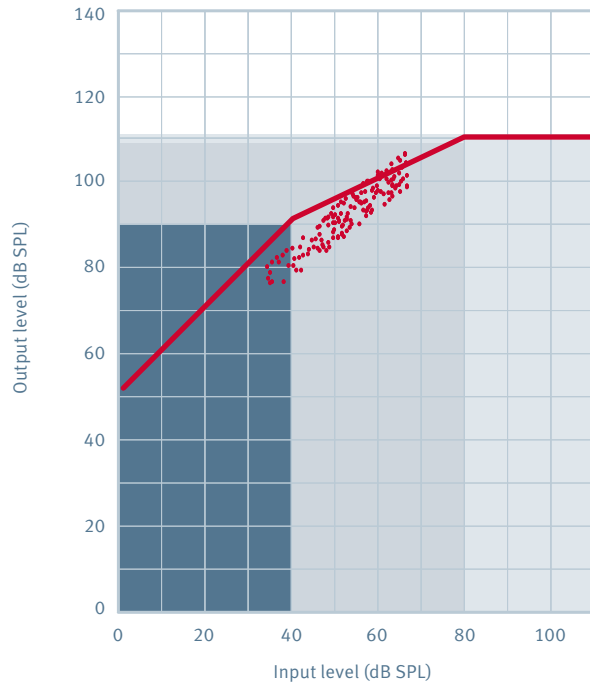

► Figure 8.13. Input/output function showing a static compressor characteristic (solid line) and the effect of attack and release times on dynamic performance (dots).

Figure 8.13 depicts the relationship between instantaneous input and output in a modern hearing aid with compression. The reason why the dots do not accurately match the input/output characteristic is that the attack and release times for the hearing aid are relatively long, so that gain adjustments do not follow the fast fluctuations of the input signal. Therefore, when discussing these issues, a distinction must be made between the static input/output curve and the dynamic performance of a compressor.

SPECIAL SIGNAL PROCESSING STRATEGIES

Special signal processing strategies have as their aim to assist the user's communication in noisy environments. One of the most effective methods for enabling communication in noisy environments is to equip the hearing aid with a directional microphone. Listening tests have shown that hearing aid users prefer the hearing aid's low-frequency gain to be reduced in noisy environments. This can be achieved through noise reduction. Another special signal processing strategy is feedback management, because feedback can be very bothersome for a hearing aid user.

Directional microphones

A directional microphone is more sensitive to sound coming from some directions than from other directions. This means that sound from some directions is amplified more than sound coming from others, where the microphone is less sensitive.

A directional microphone has two or more sound inlet ports, and directivity is obtained by combining the signals from these sound ports. The delay between the signals determines the directional microphone characteristics. The following two directional microphone arrays are described in detail:

- Array with fixed directional characteristics, two sound inlets and a diaphragm
- Array with two microphones, permitting adaptive directionality

Fixed directional system

Figure 8.14 shows a fixed directional microphone, where the sound from the front and rear inlet ports acts on the two sides of the microphone diaphragm. The rear port has an acoustic filter that delays the sound. If the delay time of this acoustic filter equals the time it takes for sound to travel from the rear port to the front port, the sound coming directly from behind will have no effect. Therefore the diaphragm does not move, and there is no electrical output. This is because the sound pressure is the same on each side of the diaphragm, and so is effectively cancelled. By varying the delay time for the rear port, the microphone's minimum sensitivity direction (null angle) can be altered.

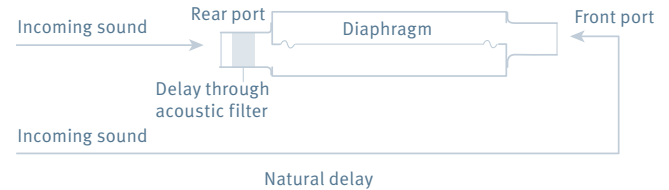

► Figure 8.14. A directional microphone consisting of a housing with two sound inlet ports. This microphone type is often referred to as a dedicated directional microphone.

Dual-microphone directional system

The fixed directional microphone offers several advantages with regard to stability and internal noise. A disadvantage is that its directivity pattern cannot be changed as the sound environment or location of the sound source changes. An adjustable directional pattern can be achieved through a combination of the signals from two (or more) omnidirectional microphones and an electrical delay. Varying the delay time will change the microphone's directivity pattern (fig. 8.15).

Frequency-dependent directional systems can be created by using band division and the directional system together.

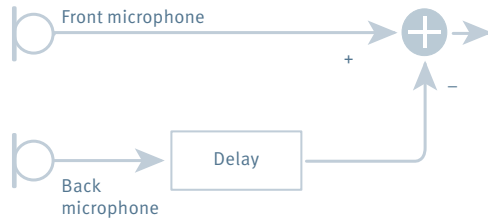

► Figure 8.15. Dual-microphone directional system. The directivity is achieved through the combination of the signals from two microphones, with one port each.

Directional characteristics

The directivity pattern of a microphone can be shown in a directional diagram called a polar plot. This depicts the sensitivity of the microphone as a function of the angle of a sound source.

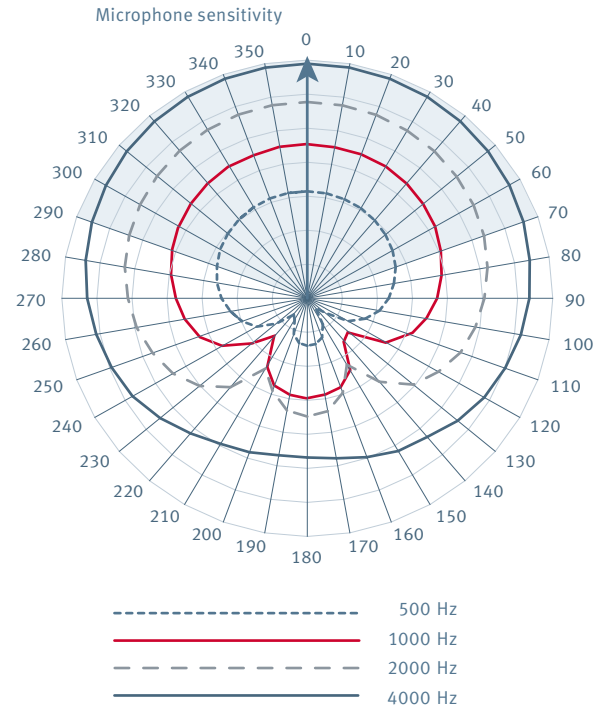

► Figure 8.16. Polar plot for a directional microphone measured in a free field. The microphone sensitivity is highest at sound angles from approximately 290 to 70 degrees.

Figure 8.16 shows the directivity pattern at four frequencies for a directional hearing aid placed in a free field. Note the almost symmetrical curves.

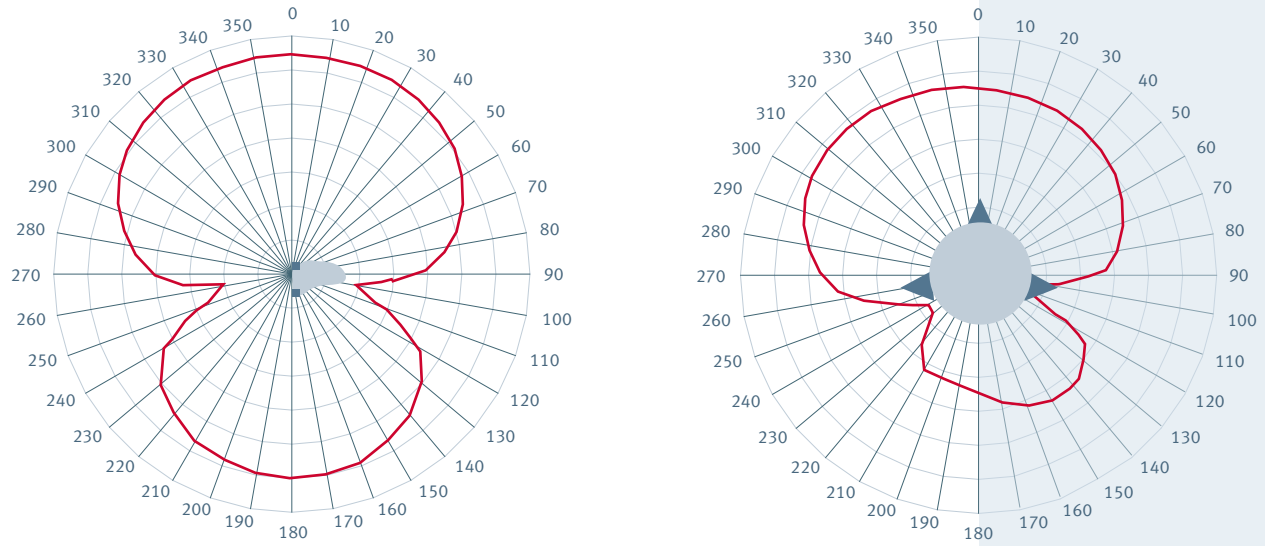

▶ Figure 8.17. Polar plot measured in a free field (left), and with the hearing aid placed on the ear of an acoustic manikin (right). The microphone sensitivity has changed due to the head shadow effect.

The characteristics of a directional microphone depend on whether the hearing aid is measured in a free field or is placed at the ear. This is illustrated in figure 8.17, which shows the characteristics of a directional microphone in a free field and with a hearing aid placed on the ear of an acoustic manikin. Note that due to the head shadow effect, the curves are no longer symmetrical. However, it is still apparent that the microphone is more sensitive to sounds coming from the front than from the back.

Directivity Index

The directional properties of a hearing aid microphone can be quantified by its Directivity Index (DI). The DI expresses the dB improvement in the signal-to-noise ratio obtained with the directional microphone in a situation where the signal comes from the front and the noise comes in equal amounts from all directions. To give an example: a directional microphone consisting of a single microphone with two sound inlet ports cannot have a directivity index exceeding 6 dB.

Adaptive directional microphone

The use of digital signal processing makes it possible to optimise the effect of a directional system in a number of sound situations.

An adaptive directional microphone adapts its directional sensitivity to the actual sound situation. To optimise speech intelligibility in background noise, speech reaching the directional microphone from the front is enhanced, while unwanted components, such as background noise, are attenuated. This is done by changing the delay time between the sound inlet ports and subtracting the signals.

An adaptive directional system continuously estimates the location of the dominant noise source in an environment and automatically attenuates this source as much as possible. The directivity pattern is changed so that it always matches the sound picture in the surroundings. This is performed by an algorithm which has as its goal to continuously analyse the sound coming from in front in relation to the sound coming from behind and the sides. The polar sensitivity of the microphones is continuously adjusted to ensure that the directional characteristics are always optimum according to the sound environment. This optimisation may be differentiated in the frequency bands of multichannel instruments.

Adaptive microphone matching

It is essential for the performance of a dual-microphone array that the absolute sensitivities of the microphones are identical at all times. Selecting microphones that are as similar as possible helps meet this challenge. However, the electro-mechanical properties of microphones tend to change over time. Although these changes are quite small, they may significantly compromise the effect of a directional system with two or more microphones. In some cases these changes can have an adverse effect, increasing noise in relation to the signal.

Digital signal processing can provide a solution to this problem. The block diagram in figure 8.18 illustrates how a signal processing system in a digital hearing aid adaptively matches the two microphones. For this system to be effective, the microphones are matched with regard to both amplitude (amplitude matching) and phase (phase matching). This matching serves to cancel out any phase or amplitude differences between the two microphones.

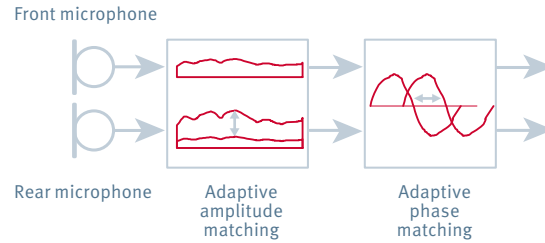

► Figure 8.18. Amplitude and phase matching is important in a multiple microphone directional system to achieve optimum directivity.

Noise classification in an adaptive directional system

Another example of digital signal processing in directional systems is adaptive signal-to-noise optimisation, which can be used to suppress wind noise and internal microphone noise. A continuous comparison of the signals from the two microphones makes it possible to determine whether the noise comes from sound sources in the surroundings, or if the noise is, for example, wind noise. Wind noise cannot be suppressed by a directional system. In fact, it will typically be perceived as being far worse with a directional system. The adaptive directional microphone can gradually reduce its directivity when wind noise and internal noise from the microphones are predominant, thus making the system less sensitive to this type of noise than fixed directional microphones.

Noise reduction

Listening tests have shown that hearing aid users prefer low-frequency gain from a hearing aid to be reduced in noisy environments. This is consistent with the fact that noise in the surroundings is predominantly low frequency in nature. A reduction of low-frequency gain will therefore mainly attenuate noise. With hearing aids that reduce low frequencies in background noise, the user does not have to turn down the volume, and speech intelligibility is not compromised.

When can noise reduction be beneficial?

The effect of noise can be limited with directional hearing aids. This improves speech intelligibility in noisy environments. However, there are many noise environments where communication is only occasionally required, for example when travelling alone in a car, train or aeroplane, or in a noisy workplace. Digital signal processing can make these situations easier for the hearing aid user. The hearing aid will be able to distinguish between speech and noise, and reduce gain when only noise is present in the surroundings, so that, in fact, the hearing aid user perceives the situation to be quieter than a person with normal hearing. In a sophisticated hearing aid, it is even possible to reduce gain at those frequencies where only noise is predominant, making it easier to separate noise from speech.

How does the hearing aid distinguish between speech and noise?

When we listen to a sound, we are rarely in doubt as to whether the sound is speech or noise. For the purpose of distinguishing between speech and noise, a hearing aid uses the fact that speech consists of a number of varying sound components that follow each other at brief intervals. If the sound variations are recorded in sound pressure level, it can be seen that there are more variations in speech than there are in noise. This distribution can be seen in figure 8.19.

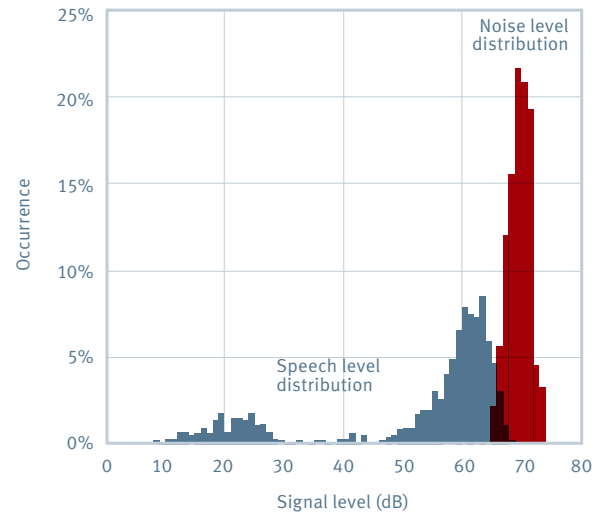

► Figure 8.19. Speech and noise level distribution over a wide range of signal levels. The dark bars represent the speech signal, which is distributed over a range from 10 to 70 dB. The red bars represent noise, which is in the range from 65 to 75 dB.

Noise reduction in a digital hearing aid

Signal processing uses the statistical differences between speech and noise to determine whether the sound signal is speech or noise, or both. Continuous statistical analysis can be made in all channels of a modern digital hearing aid. This ensures a very accurate description of the sound.

Noise reduction and speech enhancement are achieved by reducing gain in channels where noise is dominant, and increasing gain where speech is dominant. Exaggerated use of the strategy can, however, create a bubbling sound quality that many users find unpleasant.

The accurate description of sound is often used to increase noise reduction further when noise alone is registered. As soon as speech is registered, the signal processing function adapts to the new situation.

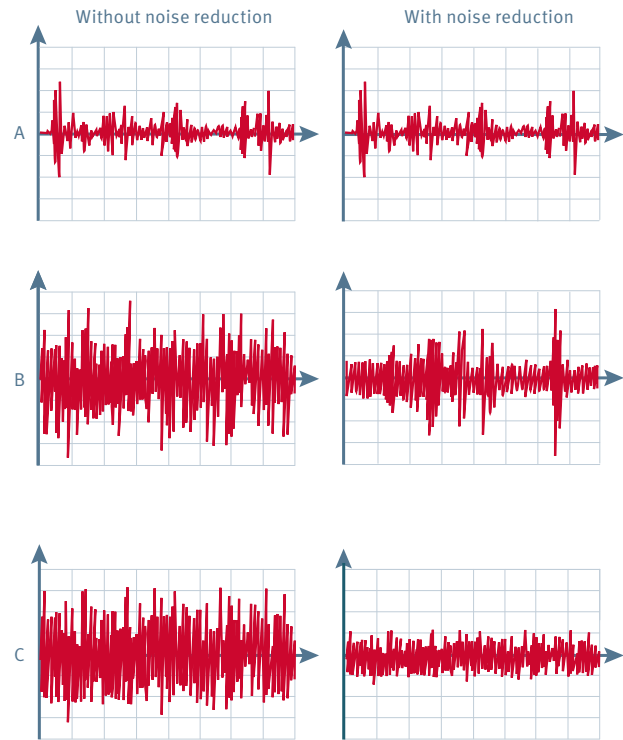

► Figure 8.20. Changes in speech spectrograms with and without noise and noise reduction. A: Speech only, B: Speech with noise, C: Noise only. The speech-characteristic peaks are clearly visible after the noise reduction system has processed the speech signal with noise (middle, right spectrogram).

Figure 8.20 illustrates the effect of noise reduction in a modern digital hearing aid. When speech without noise is detected, the noise reduction function has no effect (top). When speech and noise are present simultaneously, noise is reduced while speech remains unaffected (middle). When noise, but no speech, is registered, the noise reduction will be most effective (bottom).

Positive effect of noise reduction

There are two positive effects of noise reduction. A major advantage is that many hearing aid users find it more comfortable to be in a noisy environment for a long time. Another advantage, which can be measured in clinical trials, is improved speech intelligibility in noise. The degree of improvement depends on the type of noise – the more similar the noise is to speech, the smaller the improvement.

Feedback reduction

Feedback whistling occurs when amplified sound from the ear canal leaks back to the hearing aid microphone. The following sections describe the causes of acoustic feedback and ways to deal with the problem.

Causes of acoustic feedback

Amplified sound will, to some extent, be able to reach the hearing aid microphone through a leaking earmould or shell, or via the hearing aid vent. This unintended effect is called acoustic feedback. In most cases, acoustic feedback is harmless and inaudible, but if the hearing aid gain is high or an open fitting is used, an unstable situation can result where the hearing aid gain exceeds the attenuation provided by the earmould and distance to the microphone. This will allow some frequency components of the amplified sound to reach the microphone and be re-amplified in a self-enhancing feedback loop, and the hearing aid will whistle (fig. 8.21).

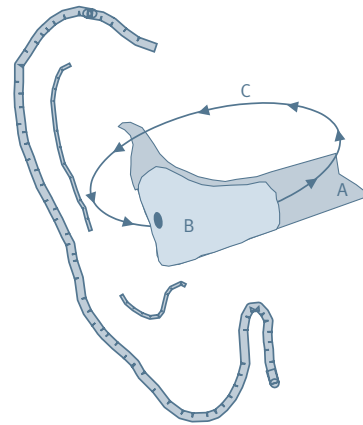

► Figure 8.21. Feedback whistling occurs when amplified sound from the ear canal (A) leaks back to the hearing aid microphone (B). The feedback path (C) is indicated by the semi-circular loop with arrows.

Feedback control through signal processing

Apart from remaking or modifying the earmould or shell, the traditional ways of avoiding feedback whistling are to reduce the vent size or reduce the hearing aid gain for high frequencies. Both methods are effective, but also have unwanted side effects. Reduction of gain can affect speech intelligibility, especially in noise, and a smaller vent size can lead to an increased perception of occlusion. Fortunately, it is not necessary to limit gain at all levels to avoid instability and hence whistling.

The use of digital signal processing can reduce the problem almost without any side effects. Two methods have proven effective:

- Limiting gain in a specific frequency region. This method is especially suited to nonlinear hearing aids.
- Active feedback suppression involves producing a signal that can cancel out the feedback signal.

Feedback reduction by limiting gain

Gain in nonlinear hearing aids is adjusted according to the input level. In ordinary listening situations, a moderate amount of gain is provided, only increasing to maximum gain in quiet surroundings. This increased amplification for quiet sounds means that acoustic feedback only occurs in quiet environments. By setting a maximum limit for gain, it is possible to avoid acoustic feedback. This way of preventing instability only affects the hearing aid gain for quiet sounds, while gain for speech and other sounds remains unaffected.

This is not the case when feedback is controlled through a general gain reduction, which also affects gain for moderate and loud input levels. Consequently, it is better to set an upper gain limit than to reduce gain in general by means of a tone control – or, for that matter, a volume control, which will not only reduce gain at all levels, but also at all frequencies.

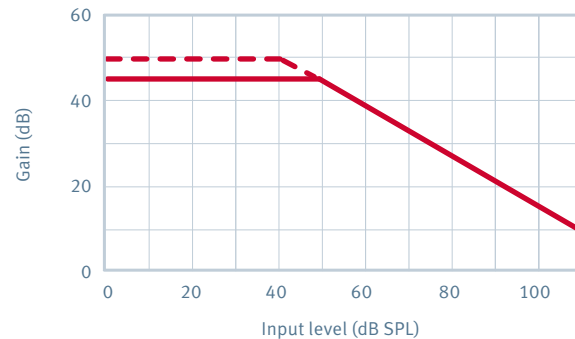
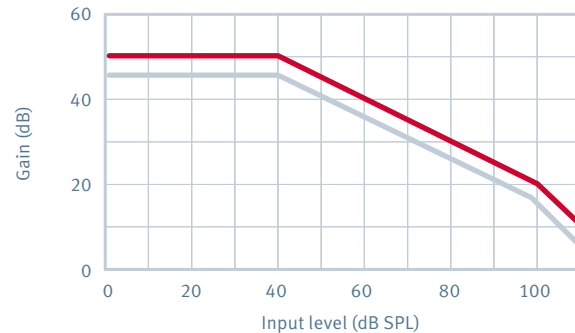

► Figure 8.22. In this example, whistling is avoided by reducing gain by 5 dB across the entire input-level range (upper drawing, lower curve) with the risk of reduced speech intelligibility. The lower illustration shows gain limiting up to 45 dB input level only (lower curve). Gain for moderate and loud sounds is not limited.

There are two ways to ensure stability for gain levels higher than 45 dB in a hearing aid with the input/gain characteristic shown in figure 8.22:

- To reduce overall gain by 5 dB (grey curve) through tone control. This approach will also affect gain for moderate and loud input levels and thus speech intelligibility.
- To limit gain to 45 dB (solid curve in the lower illustration). Gain limiting does not change gain for moderate and loud input levels. Nor does it reduce speech intelligibility.

For severe to profound degrees of hearing loss, the earmould must have a good fit, as gain may otherwise have to be limited to such an extent that speech intelligibility is compromised.

Active feedback suppression

Active feedback suppression is another method for reducing acoustic feedback. During active feedback suppression the signal processing estimates the feedback signal. The hearing aid then produces a sound of an opposite phase to cancel out the feedback signal. In this way, the estimated feedback value is subtracted from the input signal, part of which is the natural feedback signal.

Original signal = Signal including natural feedback
– estimated feedback

The subtraction of the estimated feedback value from the input signal can be achieved with a digital filter with the same characteristics as the feedback path. This filter is called a feedback path simulator.

Figure 8.23 shows a block diagram of a hearing aid with simple active feedback suppression, where a noise generator is used to determine the feedback path.

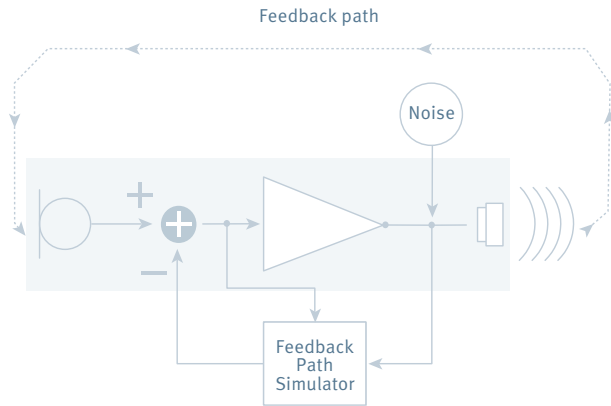

▶ Figure 8.23. Example of active feedback suppression where a noise signal is used to determine the feedback path.

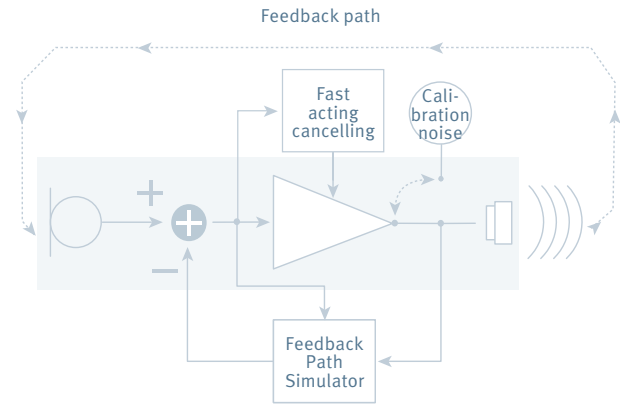

▶ Figure 8.24. Modern feedback cancellation system in a digital hearing aid. The noise generator is deactivated, and a fast-acting cancelling system is used to compensate for abrupt changes in the feedback path.

Under real-life conditions, feedback is not constant. Earmould leakage will depend on how the hearing aid user moves their jaw, for example when speaking or chewing, and the feedback path will be affected by objects close to the ear, for example when using a telephone. As a result, the filter that simulates the feedback path must also adapt quickly to the current situation. Furthermore, it is not practical to use a noise signal to determine the feedback path, as this will be audible to the user. The latest feedback suppression methods use environmental sounds to determine the feedback path. There are also adaptive systems that are optimised for fast and slow feedback path variations. Figure 8.24 shows a feedback cancellation system in a hearing aid that uses an adaptive system.

Feedback test

Some hearing aids are able to measure the feedback path during the fitting process. Such a measurement is called a feedback test and can be used for various purposes, including optimising gain limiting in relation to the individual's ear and earmould.

A feedback test can also give an indication of whether the earmould appropriately seals the ear. This is especially important for severe to profound degrees of hearing loss where the earmould fit should be as tight as possible.

OTHER SIGNAL PROCESSING APPLICATIONS

Signal processing is also applied to provide novel solutions that benefit other functions and situations concerning hearing aids. Some of these are described below.

Self-test of the hearing aid's electronic parts

The more complex the hearing aid, the more difficult it may be to test all its functions. Signal processing allows the hearing aid to test itself through automatically programmed test routines. Figure 8.25 shows a Senso Diva hearing aid performing a self-test while placed in a test cylinder.



▶ Figure 8.25. Self-test; the hearing aid emits a sound signal and measures it through its own microphones. By analysing the signals picked up, it can detect faults.

Increased comfort with reduced occlusion

Many hearing aid users experience a sensation of occlusion when hearing aids are inserted in their ears. They may perceive their own voice to be unnaturally loud and resonant. Digital signal processing can help to reduce this sensation of occlusion. Hearing aids can be provided with an Occlusion Manager, which adjusts the hearing aid's signal processing to reduce the occlusion effect.

Listening programs

Some hearing aids are equipped with a number of listening programs that can be optimised for specific listening situations. For instance, the amplification and signal processing required to listen to music in a concert hall are different from the amplification and signal processing requirements required to listen to speech in noisy environments. The capability to store different signal processing strategies for different listening situations in the one hearing aid is one of the true benefits of digital hearing aids.

A series of thin, light grey wavy lines that flow across the page from left to right, creating a sense of movement and depth. The lines are layered, with some appearing in front of others, and they all seem to originate from a point on the left side of the page.

[CHAPTER 9]

EARMOULDS AND SHELLS FOR HEARING AIDS



CHAPTER 9

EARMOULDS AND SHELLS FOR HEARING AIDS 197

Inspection of the ear canal and eardrum 198

Accumulation of ear wax 199

Skin flakes 199

Irritation of the ear canal 200

Abnormal cavities in the ear canal 200

Abnormal eardrum 201

Impression-taking 201

Insertion of an oto-block 202

Injection of the impression material 202

Checking of the finished impression 203

EARMOULD AND SHELL MANUFACTURING 204

Earmoulds and shells manufactured in an earmould laboratory 204

Manufacturing of earmoulds 205

Earmould materials 205

The earmould sound bore 207

Manufacturing of shells for in-the-ear instruments 208

Mounting the electronic components in the shell 209

The vent 209

CAMISHA – high technology manufacturing of shells and earmoulds 211

Computer modelling of the earmould or shell 212

Building up the earmould or shell 213

EARMOULDS AND SHELLS FOR HEARING AIDS

Earmoulds for behind-the-ear (BTE) models and shells for in-the-ear (ITE) models are essential parts of hearing aids. The design of these greatly affects acoustic performance and user comfort, because the actual hearing aid gain is influenced by sound bore and vent characteristics. The following aspects should be considered when making earmoulds and shells:

- The acoustic seal of the ear canal must be satisfactory
- The earmould serves as a coupler between the hearing aid and ear
- User comfort should be high to ensure long-term use
- The earmould or shell should be cosmetically acceptable
- The earmould or shell should be easy to handle

In the following pages we look at earmould and shell manufacturing: how to take a good impression, how earmoulds and shells are made, and how the finished earmould or shell can be adjusted to the individual ear.

The first thing to do after having chosen a hearing aid style is to take an impression of the client's ears. This is required to be able to make a casting form for the earmould or shell. It is recommended that clients should have their ear canals examined by a suitably qualified professional to make sure that the ear canal is in a satisfactory condition.

Taking an impression is the first step in a successful hearing aid fitting, and therefore extremely important. The key to a well fitting earmould or shell is an accurate impression.

Taking the ear impression involves two main processes: Inspection of the ear canal and eardrum, and then taking the actual impression. Many people have a sensitive ear canal and are nervous about their eardrum or hearing. It is therefore important to instruct and guide the client throughout the whole impression-taking process to make them feel secure and at ease.

Inspection of the ear canal and eardrum

It is very important to inspect the ear canal and eardrum carefully before taking an impression. For this purpose, an otoscope is used. The otoscope is equipped with a built-in lamp, which lights up the ear canal (fig. 9.01). Alternatively a video otoscope may be used, where the view of the ear canal is portrayed on a TV or computer screen.

When examining the ear canal it is important to take the ear canal anatomy into account. The outer part of the ear canal consists of cartilage and glands producing cerumen. The inner portion of the ear canal is bony and covered only by a thin layer of skin.



▶ Figure 9.01. Before taking an impression, the ear canal must be inspected by means of an otoscope.



▶ Figure 9.02. Picture of a normal eardrum, seen through an otoscope.

Through the otoscope one can see if the ear canal and eardrum look normal, or if the physical conditions are such that it is not possible to take an impression of the ear (fig. 9.02). Examples of such conditions are:

- Accumulation of ear wax
- Skin flakes
- Irritation of the ear canal
- Abnormal cavities in the ear canal
- Abnormal eardrum

Accumulation of ear wax

If plugs of ear wax have accumulated in the ear canal, they must be removed by a skilled and qualified person before an impression is taken. If this is not done, there is a risk that the impacted ear wax will be pressed further into the ear canal by the impression material. Impacted ear wax may also affect the accuracy of the impression (fig. 9.03).

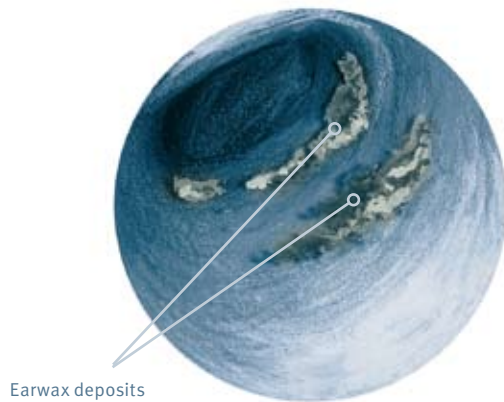

► Figure 9.03. To ensure a good earmould fit, deposits of ear wax in the ear canal must be removed before an impression is taken.

Skin flakes

The thin skin in the inner part of the ear canal is continuously being renewed. Flakes of old skin can sometimes hang from the walls of the ear canal. The skin flakes must be removed by a skilled and qualified person to avoid complications in the impression-taking (fig. 9.04).

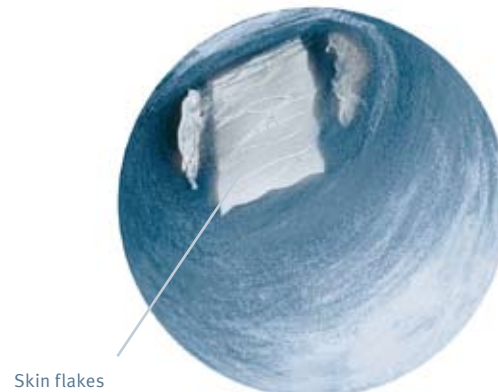

► Figure 9.04. Skin flakes in the ear canal that interfere with the process must be removed before an impression is taken.

Irritation of the ear canal

At times the ear canal can be irritated, for example with swelling or effusion of blood. In such cases, medical clearance must be obtained before an impression is taken. Irritation of an ear canal can be caused by eczema or inflammation due to an infection (fig. 9.05).

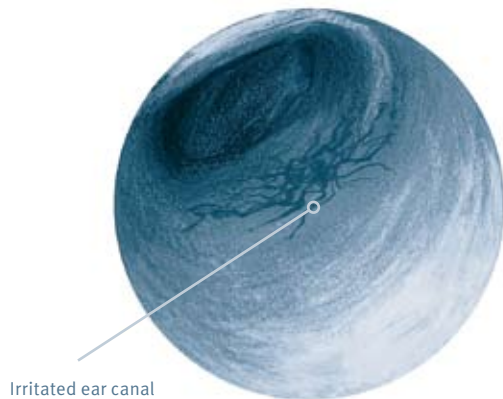

▶ Figure 9.05. An irritated ear canal should be allowed to heal before an impression is taken.

If there is a swelling in the ear canal, the impression will be smaller than if the ear canal was its normal size. This means that the finished earmould or shell will be too small and not seal the ear once the swelling disappears. An earmould that is too small may cause problems with feedback in the hearing aid, because sound leaks out of the ear canal back to the hearing aid microphone.

Abnormal cavities in the ear canal

During the otoscopy, it is important to ensure that there are no abnormal cavities in the ear canal. If diseased bone tissue has been previously surgically removed as a consequence of cholesteatoma, as described in “Types and causes of hearing loss”, an abnormal cavity can result. If this cavity is filled with impression material, it can be almost impossible to remove the impression from the ear, and surgery is sometimes required. Impressions of ears with abnormal cavities should, therefore, not be taken unless medical clearance has been obtained. In such cases it may be necessary to use several oto-blocks during impression-taking (fig. 9.06).

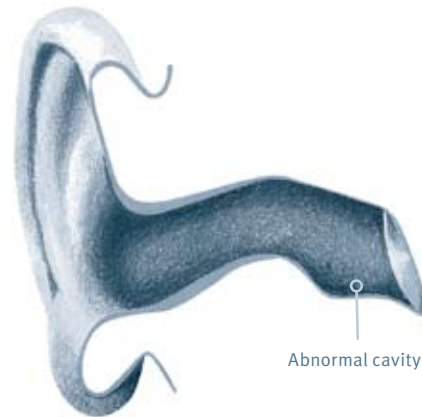

▶ Figure 9.06. Ear canal with an abnormal cavity close to the eardrum.

Abnormal eardrum

Taking an impression of an ear canal with a perforated eardrum requires great care. If it is difficult to determine whether the eardrum is actually perforated, an immit-tance measurement can be made to measure the mobil-ity of the eardrum. Another indication of a perforated eardrum is that no stapedial reflexes from the ear can be measured (fig. 9.07).

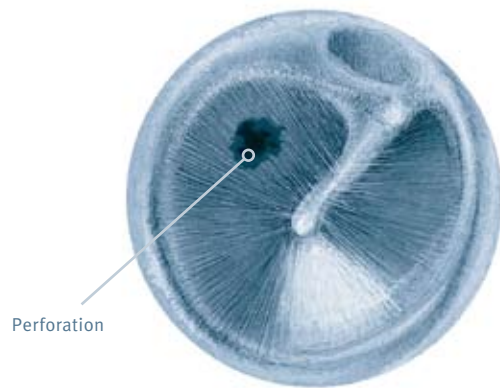

► Figure 9.07. Taking an impression of an ear canal with a perforated eardrum requires great care.

Other examples of abnormal eardrums are a distended eardrum, or if there are signs of middle ear infection or effusion in the ear canal. In each of these cases, medical clearance must be obtained before an impression can be taken.

Impression-taking

To ensure that the client is calm and relaxed during the impression-taking procedure, it may be a good idea to show the client an illustration of the anatomy of the human ear, while explaining to the client how far the im-pression material will go into the ear.

Impression-taking comprises the following steps:

- Insertion of an oto-block
- Injection of the impression material
- Checking the ear canal after the impression
- Checking of the finished impression

The following sections provide a general description of the individual steps.

There are several different kinds of impression material. The impression material chosen should always be sili-cone-based because it holds its shape well. The material is a mixture of two substances with different chemical properties. Mixing these two substances starts a chemi-cal process that gradually makes the impression mate-rial harden.

Impression materials are characterised by their viscosity and their shore values. The viscosity determines how sticky the material is when injected into the ear, and the shore value defines the material's hardness once it has cured. Material with a moderate viscosity, together with a shore value of 35-40, will usually provide a good impression resulting in a shell or earmould that fits well in the ear.

Insertion of an oto-block

Before injecting impression material into the ear, one must insert a so-called oto-block (or otostop) into the ear canal. The oto-block prevents the impression material from coming too close to the eardrum (fig. 9.08).



► Figure 9.08. An oto-block is inserted into the ear canal to protect the eardrum.

Injection of the impression material

The impression material is injected into the ear with a syringe or through a canula from a double-cartridge injector. The client should be made aware of how it feels with a blocked ear. While the impression material hardens, the client can open and close his or her mouth or make chewing movements. Studies show that it is not possible to point to any specific method that will give the best impression; it depends on the ear canal shape and hearing loss. During hardening the impression material must not be pressed further into the ear, as this will change the ear canal shape and result in an inaccurate impression (fig. 9.09).

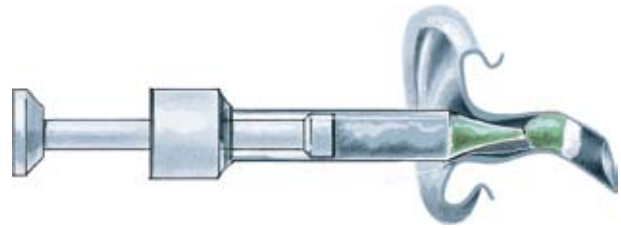

► Figure 9.09. Impression material is injected carefully into the ear canal with a syringe.

Once the impression material has hardened, the impression is carefully removed from the ear. It is not unusual to see a slight swelling of the ear canal after the impression has been removed. If another impression has to be taken, this should wait until the swelling has disappeared, as the final impression will otherwise be too small. When the impression has been removed, the ear canal must be inspected to ensure that nothing has been left behind.

Checking of the finished impression

When the impression has been removed from the ear, the impression must be checked for irregularities, such as dents or unfilled gaps or air holes. An impression that is not solid gives a poorly fitting earmould or shell, and can be the cause of acoustic feedback. It is also important to check that the impression extends past the second bend of the ear canal. This is especially important for the manufacture of CIC instruments, which are worn deep in the ear canal (fig. 9.10).

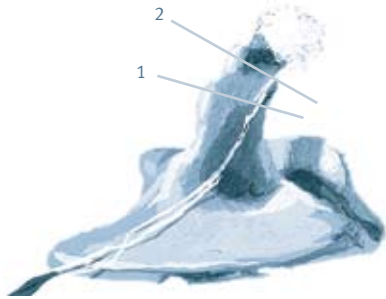

► Figure 9.10. Impression with an oto-block. Note the visible first (1) and second (2) bend in the ear canal.

The finished impression of the ear is sent to the manufacturer or an earmould laboratory. It is a good idea to include the audiogram with the impression, as well as to indicate whether there are special preferences with regard to vent size. The choice of earmould or type of in-the-ear instrument depends on several factors, such as the shape of the ear and the hearing loss of the client. The impression and audiogram allow the earmould laboratory to determine how the earmould or shell should be constructed, making allowance for the shape of the ear and the acoustic requirements of the hearing loss.

EARMOULD AND SHELL MANUFACTURING

Earmoulds and shells can be manufactured in two ways. The traditional method is to make a control form on the basis of the impression. A newer method is to manufacture the earmould or shell using scanner and computer modelling technology.

Earmoulds and shells manufactured in an earmould laboratory

At the earmould laboratory the impression is trimmed and the surface treated with paraffin wax. A reference control form of silicone is then made on the basis of the impression. The next step is to shape the impression into the same shape as the desired hearing aid model, for example a CIC or ITE, or an earmould for a BTE hearing aid. Another casting form is then made of photogel or silicone.

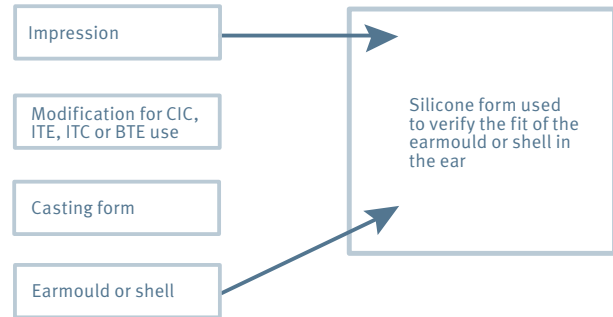

► Figure 9.11. Cutting and grinding of the impression and manufacture of a silicone form to verify that the earmould or shell fits into the ear. On the basis of the impression, a casting form is made to enable casting of the final earmould or shell.

Manufacturing of earmoulds

Two main types of material are used to make earmoulds. Photoplastic or acrylic material is used to make hard earmoulds, while soft earmoulds are often made of silicone. The table below shows the properties of the individual earmould materials.

TYPE	MATERIAL	PROPERTIES
Hard earmould	Photoplastic material (UV), which cures by exposure to ultra-violet light, or acrylic (PMMA), cold or hot cured	<ul style="list-style-type: none"> • easy to keep clean • easy to grind if adjustments are required
Soft earmould	Silicone	<ul style="list-style-type: none"> • is shaped according to the form of the ear at body temperature • suitable for active children • difficult to keep clean • generates warmth in the ear • mostly used for severe degrees of hearing loss to avoid feedback whistling

▶ Table 9.01. Earmould materials

Earmould materials

The earmould is cast by injecting liquid photoplastic into the casting mould. When the "raw" earmould is hard in the form, it is removed. Then it is ready for final preparation and finishing. The earmould is shaped to have the desired acoustic properties and conform with the hearing loss, hearing aid type and dimensions of the ear. It is also important that the earmould is cosmetically acceptable to the user.

Earmoulds come in several varieties. The main types of earmoulds for behind-the-ear hearing aids are depicted in table 9.02.

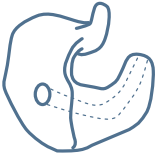
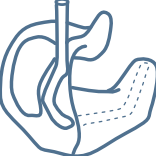
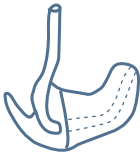
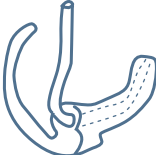
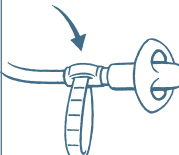
EARMOULD TYPE	APPLICATION AND PROPERTIES
	<p>Shell mould, suitable for severe to profound hearing loss requiring a high amount of amplification. The mould fills the outer ear (concha), and the mould fits tightly in the ear canal. This reduces the risk of feedback whistling in the hearing aid. The upper part of the mould is provided with a helix lock in the top corner of the concha bowl.</p>
	<p>Skeleton mould, suitable for moderate hearing loss. It is an earmould with a bow supported by the outer ear. The upper part of the mould is provided with a helix lock in the top corner of the concha bowl.</p>
	<p>Canal lock, suitable for mild hearing loss. The entire mould is worn discreetly in the ear canal. A canal type earmould can be easier to insert into the ear than the skeleton type, whose bow must be positioned correctly in the concha cavity. If the ear canal is very straight, a canal mould may have a tendency to work its way out of the ear. In these cases, it is often better to make a skeleton mould.</p>
	<p>Open mould, the mould and the sound bore only fill part of the ear canal entrance. Open earmoulds are sometimes used for high-frequency hearing loss, where the natural low-frequency sound should be allowed to get past the sound bore of the mould, or for CROS hearing aids used for unilateral profound hearing loss.</p>
	<p>As an open mould only fills part of the ear canal, standard fit components can be used. These generally consist of a non-occluding ear-set with an anchor, which lies in the concha bowl or ear canal and is connected to the tubing. As the standard fit components can be individualised to fit different ears, the impression-taking procedure is negated. Standard fit open moulds are commonly used for high-frequency hearing losses.</p>

▶ Table 9.02. Earmould types, application and properties

The earmould sound bore

The sound from the hearing aid is directed into the ear through the earmould sound bore. The cross sectional area and length of the bore are very important for the acoustic performance of the earmould. A sound bore diameter of 2-3 mm is adequate for most hearing aid users.

If additional high-frequency gain is required, the sound bore can be shaped like a horn whose diameter increases gradually towards the bore outlet in the ear canal. The effect of the horn depends on its length and how much the diameter increases through the horn. These factors determine the cut-off frequency of the horn. If the diameter increases too much over a short distance, the cut-off frequency will be beyond the hearing aid frequency range, and the horn will be ineffective.

The following rule of thumb for the diameter of the horn can be used:

The maximum diameter of the horn should not be more than twice the diameter of the narrowest part of the sound bore.

Usually the horn is formed by using a horn shaped insert or a horn shaped tubing/insert system (fig. 9.12).

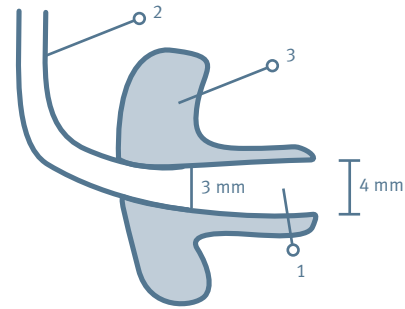

► Figure 9.12. A 4-mm horn (1) inserted in the sound bore (2) of an earmould (3).

In rare cases of low frequency hearing loss, it may be necessary to reduce high-frequency gain. This may be done by reducing the sound bore to a diameter of, e.g., 1 mm in the medial end of the earmould (called a constriction), and by widening the sound bore.

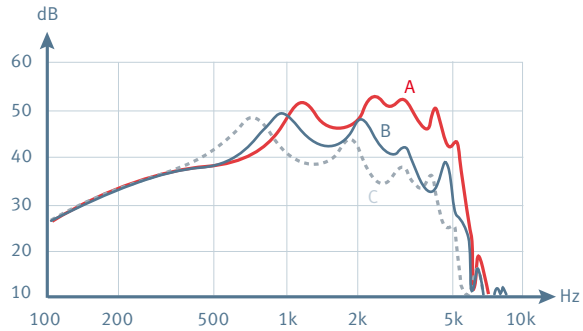

► Figure 9.13. Effect on gain of various sound bore profiles. (A) Horn shaped, (B) Cylindrical (2 mm), (C) Cylindrical (1 mm). If the sound canal is horn shaped (A), a boost of approx. 10 dB is provided in the range between 2 and 6 kHz.

Manufacturing of shells for in-the-ear instruments

For ITE or CIC hearing aids it is important to pay attention to the dimensions of the ear canal. If the entrance to the ear canal is very narrow, or the first ear canal bend is very sharp, it may be necessary to make a concha model instead.

When making an ITE or CIC instrument, the impression of the ear is used to cast the photoplastic shell which will house the electronic parts. It is usually the manufacturer of the chosen hearing aid model that makes the shell and assembles the hearing aid.

As described in the chapter "Hearing aid types", an in-the-ear instrument can be made in various sizes, depending on the size of the client's concha and ear canal and the degree of hearing loss. To a large extent the shape of the shell depends on the dimensions of the ear and the space required for the electronic components.

At times the hearing aid has to be larger than anticipated to make room for all the components.

As with earmoulds, ITE shells are either made from photoplastic or acrylic material. The manufacturing process includes making a control form as well as a casting form. The major difference is that, before the material is completely hardened, the casting mould is turned upside down to allow excess material to run out, leaving only the thin hardened shell remaining in the form.

Mounting the electronic components in the shell

During grinding the shell is closely monitored to determine when it has the optimum height to allow mounting of the faceplate. Once the grinding and lacquering work is finished, the electronics can be mounted.

With the electronic components in place the faceplate is glued on. The faceplate contains the program switch, battery drawer cover and, in some models, a volume control. Hearing aids that are worn deep in the ear canal can also be provided with an extraction cord fastened in the faceplate.

The sound outlet is usually protected by a wax guard to prevent ear wax from entering the outlet and sticking to the hearing aid receiver (fig. 9.14).



► Figure 9.14. A shell with a visible faceplate and electronics.

The vent

Venting of the earmould or shell increases the risk of feedback. It may also reduce the amount of gain that can be provided without whistling, as any leakage can cause feedback. The vent size depends on the user's gain requirements and whether there are occlusion problems. Occlusion will be described in greater detail later in this section.

As a typical guide, in the case of mild hearing loss, a relatively large vent of 2 mm or more can be used. For moderate to severe hearing loss, the vent should only be around 1 mm due to the increased risk of feedback. Hearing aids for profound hearing loss should be unvented for the same reason (fig. 9.15).

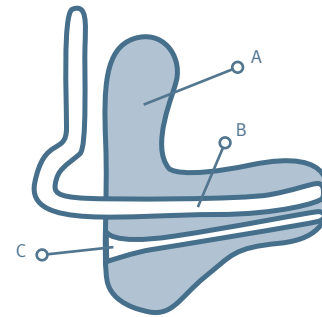

► Figure 9.15. Example of a vent (C) and a sound bore (B) in an earmould (A).

When an earmould or a hearing aid is placed in the ear, it partially blocks the ear canal. Due to this blockage, the user may hear his or her own voice louder, and the voice may also sound hollow, as if one was talking inside a barrel. This phenomenon is called the occlusion effect.

A prime cause of the occlusion effect is from vibrations of the wall of the ear canal. When we are talking or eating, vibrations from the vocal chords or sound generated by chewing is transmitted via the skull. This makes the walls of the soft part of the ear canal vibrate, acting like a sound membrane. When the ear is closed by an earmould or shell, these vibrations create a much higher sound pressure level than in an open ear. The sound pressure level thus generated at the eardrum can be up to 30 dB higher in the occluded (closed) ear, depending on the frequency. The occlusion effect is a problem, especially at low frequencies (i.e. below 1 kHz).

The occlusion effect can be reduced or eliminated by a vent in the earmould or shell. This is an additional bore parallel with the sound bore. It connects the residual canal volume with the air outside the ear. The larger the vent the more efficient the reduction of the occlusion effect. The vent diameter is chosen on the basis of the same criteria used with earmoulds, that is to reduce the occlusion effect and increase comfort, or to lower the low-frequency gain (fig. 9.16).

There may also be other reasons for making a vent, for example to aerate the part of the ear canal that is between the hearing aid/earmould and the eardrum. Sometimes a comfort vent of a diameter of 1 mm or less is preferred. The purpose of this type of vent is to reduce variations in the static pressure occurring when the earmould is inserted into or removed from the ear.

Another type of vent is the bass-cut vent. This is used in connection with high-frequency hearing loss where there is minimal or no need for low-frequency amplification. The extent to which low-frequency amplification is reduced depends on the diameter of the vent. Alternatively, an open mould can be chosen, which is also suitable for reducing the occlusion effect.

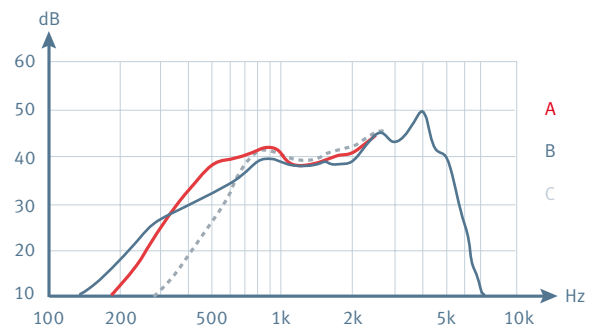

► Figure 9.16. Effect of different vent diameters on the amplification from a hearing aid. (A) 2 mm, (B) No vent, (C) 3 mm. The drawing shows that the amplification obtained with a vent of 3 mm (C) is less than with a vent of 2 mm or with no vent for frequencies below 500 Hz.

There are three main effects from venting: reduction of occlusion, reduction of low-frequency amplification and aeration of the ear canal. It is not possible to choose one effect without involving the other two effects.

Vents in shells are of many types, for example: A standard moulded vent, coupled cavity vent or vario vent. A standard moulded vent is a vent with a uniform diameter through the entire shell. A coupled cavity vent may consist of a thin tube coupling the residual canal volume between the shell and the eardrum with the inner open space of the hearing aid. The vario vent allows variation of the vent size by means of different sized inserts.

Besides the many adjustment options available in modern hearing aids, the earmould technician can also optimise the hearing aid's acoustic characteristics, for example by sound or vent modifications. It is, however, important to keep in mind that some hearing aid features may not function optimally with a very large vent. If the hearing aid has a noise reduction function, the user may perceive some reduction in the effect, as the noise circumvents the function and passes directly through the large bass-cut vent of the earmould. Similarly, the effect of a directional microphone can be reduced.

CAMISHA – high technology manufacturing of shells and earmoulds

New technology has since 2001 made it possible to manufacture shells and earmoulds with an even higher degree of precision and improved cosmetic appeal, i.e. reduced size due to thinner shells and more effective geometry than before.

The general term for the system is CAMISHA (Computer Aided Manufacturing of Individual Shells for Hearing Aids). The procedure involves scanning the surface of the impression by means of laser technology, while cameras take photos of the impression from different angles. This gives information about the impression's measurements, shape, curve, etc (fig. 9.17).

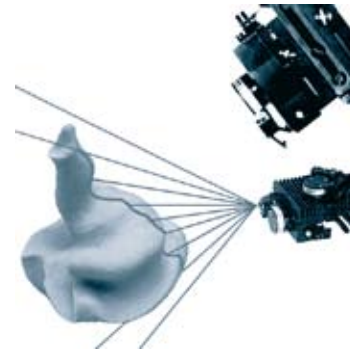

► Figure 9.17. Laser beams and cameras are used to scan and photograph the impression.

Computer modelling of the earmould or shell

The collected data is transmitted to computer software, which makes a three-dimensional model of the impression. The model visualised on the computer screen can be modified in different ways, for example the shape and thickness of the shell, position of sound bore and vent, etc (fig. 9.18).

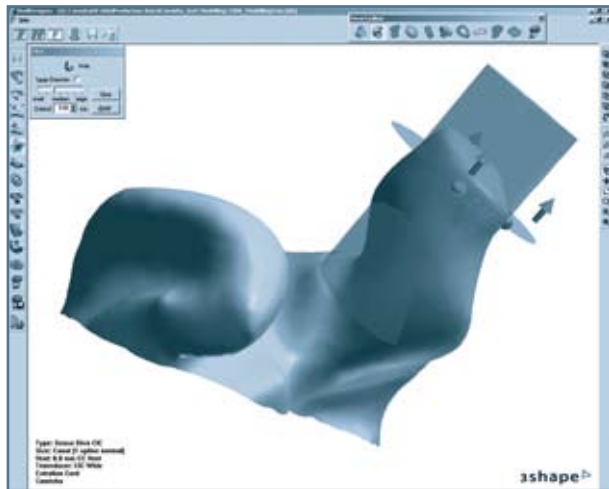

▶ Figure 9.18. 3D wire frame over the shell profile.

Finally, a virtual 3D model is made, showing the shape of the final shell (fig. 9.19). The model can be turned and displayed from different angles. It can be checked to ensure that the electronic parts fit into the shell, and the shell fits into the shape of the ear – or whether the shell needs to be trimmed to avoid irritation of the ear canal.

The sound bore and the vent are then incorporated into the model.

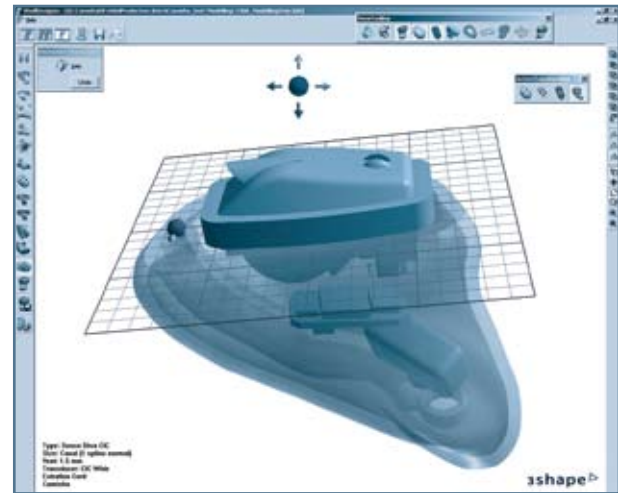

▶ Figure 9.19 3D model of the final shell showing the positioning of the electronic components.

Building up the earmould or shell

When the shell has been modelled, all the data is transmitted to a machine which builds the shell, layer by layer. Two methods are used. One is called SLA (Stereo Lithography Apparatus), which uses liquid photoplastic acrylic material that is hardened layer by layer by a laser beam. The other method is the SLS (Selective Laser Sintering) method, where a nylon powder is used. Here a laser beam melts and sinters each layer. With both methods large batches of shells or earmoulds can be produced.

Once the shell has been built, the electronic components are put in place in the same way as usual. Now the finished hearing aid is ready to be fitted to the client (fig. 9.20). All data concerning the individual shell is stored in the software and can be used at a later time to make an exact copy, if necessary.

The CAMISHA system offers many advantages: increased precision and homogeneity in the manufacture of hearing aid shells and earmoulds, a better fit of the hearing aid, increased comfort and reduced risk of feedback whistling.

In the near future it will be possible to scan the shape of the ear, making it unnecessary to take an impression of the client's ear. The scanned data can be transmitted directly to the laboratory where the shell or earmould is made. This saves time and makes the finished hearing aid available sooner.



▶ Figure 9.20. CIC hearing aids (left) and ITE hearing aids (right).

SOUND AND HEARING INDEX



INDEX

A

A/D converter	144, 147
age-related hearing loss	68
air conduction	83
amplifier.....	147
circuit board	150
thick-film.....	151
thin-film	150
amplitude.....	11
aperiodic sounds.....	21
ascending method.....	52, 84
attack time	171
variation of.....	179
audiogram.....	80, 81
audiometer.....	79
auditory evoked potentials.....	95
Automatic Gain Control, AGC	110, 170
Automatic Output Control, AOC	174

B

basilar membrane	44
travelling wave on	48
battery	157, 159
lifetime.....	158
usage pattern.....	158
voltage	158
behind-the-ear hearing aid	122
BICROS.....	126, 128
binary number system	144
body-worn hearing aid	125
bone-anchored hearing aid, BAHA.....	130
bone conduction	84
bone conduction hearing aid	129

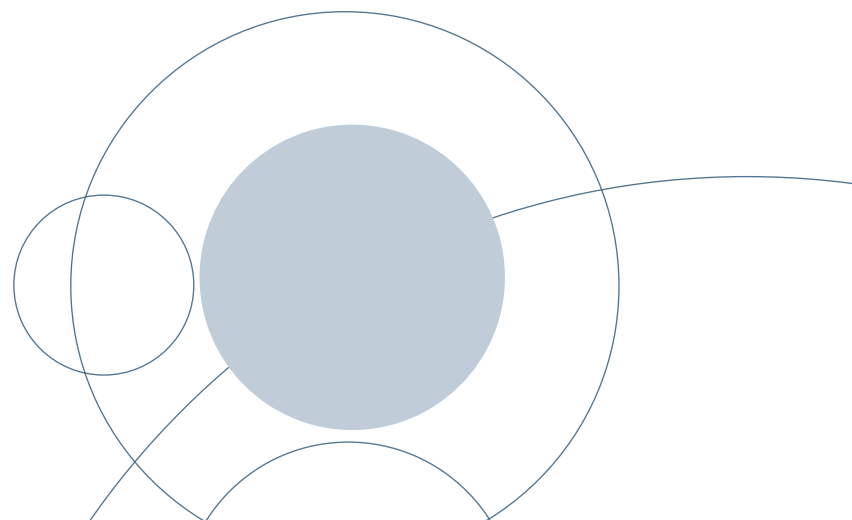

C ● ● ● ● ● ● ● ● ● ● ● ● ● ● ● ●

CAMISHA.....	211
canal lock.....	206
children	
hearing assessment	82
cholesteatoma	65
cochlea.....	43
cochlear implants.....	132
completely-in-canal.....	124
components	
hearing aid	139
compression.....	110, 170, 177
frequency-dependent.....	177
multi-segment.....	178
ratio	170
threshold	170
computer modelling	
earmould.....	212
condenser microphone.....	139
conductive hearing loss.....	62, 85
contralateral routing of signal.....	126
coupled cavity vent	211

D ● ● ● ● ● ● ● ● ● ● ● ● ● ● ● ●

dB HL	80
dB SPL.....	15, 80
decade	11
decibel scale	14
Desired Sensation Level	116
digital signal processing, DSP	
custom.....	149
open-platform	149
digitising	144
directional characteristics	183
directional microphone	141, 182
adaptive.....	185
dedicated.....	142, 182
dual-microphone.....	142, 183
matching.....	186
directional system	
noise classification	186
directivity index	184

E ● ● ● ● ● ● ● ● ● ● ● ● ● ● ● ●

ear canal	39
abnormal cavity	200
eardrum	198
earwax	199
inspection	198
irritation	200
normal eardrum	198
perforated eardrum	201
resonance	40
resonant frequency	40
skin flakes	199
swelling	200
earmould	
computer modelling	212
effect of different vents	210
horn	207
manufacturing	204, 205
materials	205
sound bore	207
types	206
earphones	83
ear wax accumulation	63, 199
electret microphone	139, 140
electronic components	
mounting in the shell	209
Eustachian tube	41

F ● ● ● ● ● ● ● ● ● ● ● ● ● ● ● ●

faceplate	123, 138
Fast Fourier Transform, FFT	178
feedback	126
causes of	189
control of	190
reduction of	189
test	192
filter	
design	151
discrete-time	154
FFT	154
high-cut	152
low-cut	152
multiple-band	153
filter bands	
implementation	153
fitting rules	
generic	115, 116
nonlinear	116
FM receiver	144
frequency	10
characteristic	169
dependent compression	177
full concha	123

G ● ● ● ● ● ● ● ● ● ● ● ● ● ● ● ●

gain	
input/gain	171
limiting.....	190, 191

H ● ● ● ● ● ● ● ● ● ● ● ● ● ● ● ●

hair cells.....	46, 47, 66
half concha.....	123
half gain rule	115
hearing aid	
basic principle.....	103
block diagram	137
components	138
controls.....	156
digital.....	113
progress.....	114
self-test.....	193
switch	156
types.....	104, 113
hearing loss	
conductive	62, 85
hereditary	71
mixed	86
noise-induced	69
presbycusis.....	68
sensorineural	66
hearing test	52, 79
hearing threshold	52, 81
HI-PRO.....	109
high-cut filter	152
high input levels.....	174
HIMSA	109
hybrid amplifier.....	147

M

malleus 41

manufacturing

- earmould and shell 204

masking 55, 87

maximum power output 167

mercury battery..... 159

microphone..... 139

- adaptive..... 185
- directional..... 141
- electret..... 139
- matching 186
- noise..... 186
- omnidirectional..... 141

middle ear 41

- infection..... 64

Most Comfortable Loudness, MCL 90

multiple-band filter 153

muscles

- stapedius..... 42
- tensor tympani..... 42

N

NAL 116

NOAH 109

noise reduction 187, 188

nonlinear amplification 110

O ● ● ● ● ● ● ● ● ● ● ● ● ● ● ● ●

occlusion	
effect	210
manager.....	193
octave	11
omnidirectional microphone.....	141
open mould	206
operating voltage	158
Organ of Corti.....	46
ossicles	41, 65
otitis media	64
acute	64
chronic.....	64
oto-block.....	202
otosclerosis.....	65
otoscope	198
outer hair cells.....	47

P ● ● ● ● ● ● ● ● ● ● ● ● ● ● ● ●

Pascal, Pa	14
peak clipping, PC.....	174
perforated eardrum	201
periodic sounds	20
permanent threshold shift, PTS.....	69
phase.....	12
phon curves	67
polar plot.....	183
Presbycusis.....	68

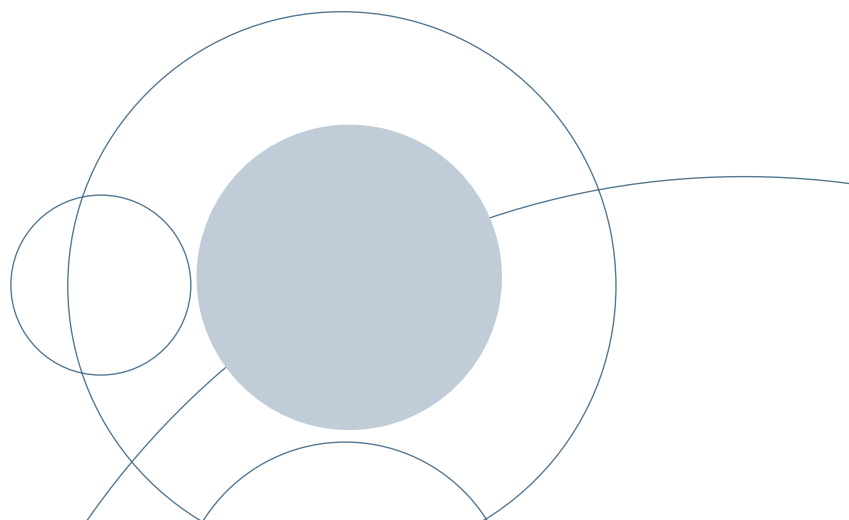

Q ● ● ● ● ● ● ● ● ● ● ● ● ● ● ● ●

quantisation..... 146

R ● ● ● ● ● ● ● ● ● ● ● ● ● ● ● ●

receiver 155
recruitment 66, 111
reference level, dB SPL..... 15
regulation speed 171
 effect on output 180
 variation of..... 179
Reissner's membrane 44
release time 171
 variation of..... 179
remote control..... 157
resonance 29
resonant frequency 40
round window 45

S ● ● ● ● ● ● ● ● ● ● ● ● ● ●

sampling frequency.....	145
scala media.....	44
scala tympani.....	44
scala vestibuli	44
self-test	
hearing aid.....	193
sensorineural hearing loss	66, 85
shell	
CAMISHA.....	211
manufacturing.....	204, 208
mounting electronic components	209
Sigma-Delta converter.....	147
signal-to-noise ratio	146
sine function	9
skeleton mould.....	206
sound.....	7
aperiodic.....	21
bore	207
complex	18
periodic.....	20
pressure.....	7, 14

spectacle hearing aid	106
spectral analysis	18
spectrogram.....	23
spectrum of sound signal	18
speech audiometry.....	88
speech intelligibility.....	187
speech reception threshold, SRT	89
speech signal.....	22, 23
speed of sound	10
standard batteries.....	157
stapedial reflex	42
stapes.....	41, 42
ossification of	65
stereocilia	47
stria vascularis.....	46

T ● ● ● ● ● ● ● ● ● ● ● ● ● ●

tectorial membrane	46
telecoil	143, 156
temporary threshold shift, TTS	69
test	
booth	79
feedback	192
hearing threshold	52
tinnitus.....	73, 131
transistor hearing aid	106
transport holder	138
travelling wave	48
trimmers	107
tympanometry.....	92

U ● ● ● ● ● ● ● ● ● ● ● ● ● ●

uncomfortable loudness, UCL.....	90
----------------------------------	----

V ● ● ● ● ● ● ● ● ● ● ● ● ● ●

vacuum tube	105
vent	
coupled cavity.....	211
effect of.....	210
vario.....	211
vibrations	
harmonic.....	8
mechanical.....	139
Visual Reinforcement Audiometry.....	82
volume control	156

W ● ● ● ● ● ● ● ● ● ● ● ● ● ●

wavelength	9
wax plug.....	63
WDRC	112, 176
wind noise.....	139, 186

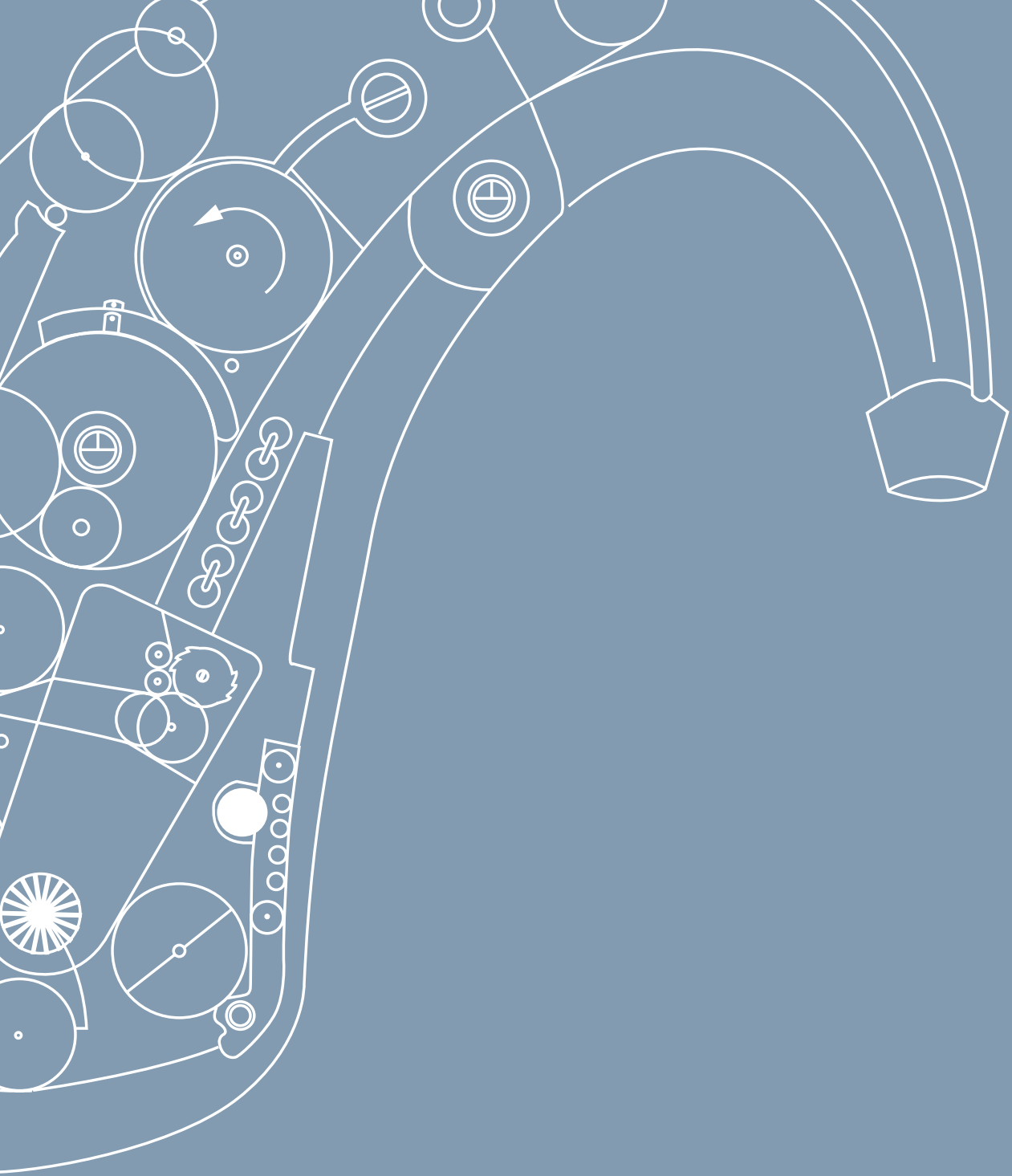



www.widex.com
www.hear-it.org



ISBN # 87-985233-9-2

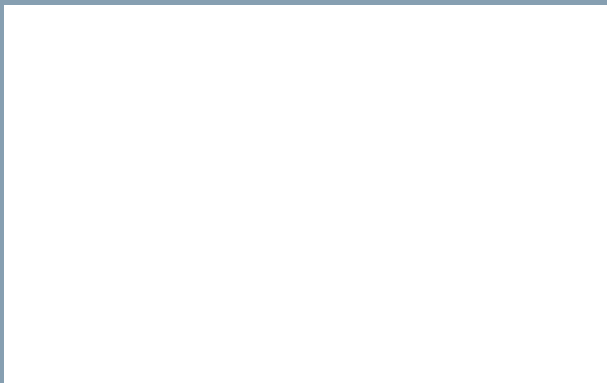

WIDEX[®]
high definition hearing



Printed by FB /03-07
9 502 0170 001 #01